



# A827

## *Professional Multichannel Tape Recorder*

### **Operating Instructions**

Prepared and edited by:  
Studer Professional Audio AG  
Technical Documentation  
Althardstrasse 30  
CH-8105 Regensdorf - Switzerland  
<http://www.studer.ch>

Copyright by Studer Professional Audio AG  
Printed in Switzerland  
Order no. 10.27.1403 (Ed. 0502)

Subject to change

---

Studer is a registered trade mark of Studer Professional Audio AG, Regensdorf



To reduce the risk of electric shock, do not remove covers (or back). No user-serviceable parts inside. Refer servicing to qualified service personnel.

Afin de prévenir un choc électrique, ne pas enlever les couvercles (où l'arrière) de l'appareil. Il ne se trouve à l'intérieur aucune pièce pouvant être réparée par l'utilisateur.

Um die Gefahr eines elektrischen Schlages zu vermeiden, entfernen Sie keine Geräteabdeckungen (oder dessen Rückwand). Überlassen Sie Wartung und Reparatur qualifiziertem Fachpersonal.

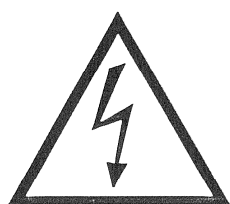

This symbol is intended to alert the user to presence of uninsulated "dangerous voltage" within the apparatus that may be of sufficient magnitude to constitute a risk of electric shock to a person.

Ce symbole indique à l'utilisateur qu'il existe à l'intérieur de l'appareil des "tensions dangereuses". Ces tensions élevées entraînent un risque de choc électrique en cas de contact.

Dieses Symbol deutet dem Anwender an, dass im Geräteinnern die Gefahr der Berührung von "gefährlicher Spannung" besteht. Die Größe der Spannung kann zu einem elektrischen Schlag führen.



This symbol is intended to alert the user to the presence of important instructions for operating and maintenance in the enclosed documentation.

Ce symbole indique à l'utilisateur que la documentation jointe contient d'importantes instructions concernant le fonctionnement et la maintenance.

Dieses Symbol deutet dem Anwender an, dass die beigelegte Dokumentation wichtige Hinweise für Betrieb und Wartung enthält.

**CAUTION:**

Lithium battery. Danger of explosion by incorrect handling. Replace by battery of the same make and type only.

**ATTENTION:**

Pile au lithium. Danger d'explosion en cas de manipulation incorrecte. Ne remplacer que par un modèle de même type.

**ACHTUNG:**

Explosionsgefahr bei unsachgemäßem Auswechseln der Lithium-batterie. Nur durch den selben Typ ersetzen.

**ADVARSEL:**

Lithiumbatteri. Eksplosionsfare. Udskiftning må kun foretages af en sagkyndig og som beskrevet i servicemanualen (DK).

**FIRST AID**

(in case of electric shock)

1. Separate the person as quickly as possible from the electric power source:
  - by switching off the equipment
  - or by unplugging or disconnecting the mains cable
  - pushing the person away from the power source by using dry insulating material (such as wood or plastic).
  - *After having sustained an electric shock, always consult a doctor.*

**WARNING!**

DO NOT TOUCH THE PERSON OR HIS CLOTHING BEFORE THE POWER IS TURNED OFF, OTHERWISE YOU STAND THE RISK OF SUSTAINING AN ELECTRIC SHOCK AS WELL!

2. If the person is unconscious:
  - check the pulse,
  - reanimate the person if respiration is poor,
  - lay the body down, turn it to one side, call for a doctor immediately.

**PREMIERS SECOURS**

(en cas d'électrocution)

1. Si la personne est dans l'impossibilité de se libérer:
  - Couper l'interrupteur principal
  - Couper le courant
  - Repousser la personne de l'appareil à l'aide d'un objet en matière non conductrice (matière plastique ou bois)
  - *Après une électrocution, toujours consulter un médecin.*

**ATTENTION!**

NE JAMAIS TOUCHER UNE PERSONNE QUI EST SOUS TENSION, SOUS PEINE DE SUBIR EGALEMENT UNE ELECTROCUTION.

2. En cas de perte de connaissance de la personne électrocutée:
  - Contrôler le pouls
  - Si nécessaire, pratiquer la respiration artificielle
  - Placer l'accidenté sur le flanc et consulter un médecin.

**ERSTE HILFE**

(bei Stromunfällen)

1. Bei einem Stromunfall die betroffene Person so rasch wie möglich vom Strom trennen:
  - Ausschalten des Gerätes
  - Ziehen oder Unterbrechen der Netzzuleitung
  - Betroffene Person mit isoliertem Material (Holz, Kunststoff) von der Gefahrenquelle wegstoßen
  - *Nach einem Stromunfall sollte immer ein Arzt aufgesucht werden.*

**ACHTUNG!**

EINE UNTER SPANNUNG STEHENDE PERSON DARF NICHT BERÜHRT WERDEN. SIE KÖNNEN DABEI SELBST ELEKTRISIERT WERDEN!

2. Bei Bewusstlosigkeit des Verunfallten:
  - Puls kontrollieren,
  - bei ausgesetzter Atmung künstlich beatmen,
  - Seitenlagerung des Verunfallten vornehmen und Arzt verständigen.

**Installation**

Vor der Installation des Gerätes müssen die hier aufgeführten und auch die weiter in dieser Anleitung mit  bezeichneten Hinweise gelesen und während der Installation und des Betriebes beachtet werden.

Untersuchen Sie das Gerät und sein Zubehör ist auf allfällige Transportschäden.

Ein Gerät, das mechanische Beschädigung aufweist oder in welches Flüssigkeit oder Gegenstände eingedrungen sind, darf nicht ans Netz angeschlossen oder muss sofort durch Ziehen des Netzsteckers vom Netz getrennt werden. Das Öffnen und Instandsetzen des Gerätes darf nur von Fachpersonal unter Einhaltung der geltenden Vorschriften durchgeführt werden.

Falls dem Gerät kein konfektioniertes Netzkabel beiliegt, muss dieses durch eine Fachperson unter Verwendung der mitgelieferten Kabel-Gerätendose IEC320/C13 oder IEC320/C19 und unter Berücksichtigung der einschlägigen, im jeweiligen Lande geltenden Bestimmungen angefertigt werden; siehe unten.

Vor Anschluss des Netzkabels an die Netzsteckdose muss überprüft werden, ob die Stromversorgungs- und Anschlusswerte des Gerätes (Netzspannung, Netzfrequenz) innerhalb der erlaubten Toleranzen liegen. Die im Gerät eingesetzten Sicherungen müssen den am Gerät angebrachten Angaben entsprechen.

Ein Gerät mit einem dreipoligen Gerätestecker (Gerät der Schutzklasse I) muss an eine dreipolige Netzsteckdose angeschlossen und somit das Gerätegehäuse mit dem Schutzleiter der Netzinstallation verbunden werden (Für Dänemark gelten Starkstrombestimmungen, Abschnitt 107).

**Installation**

Before you install the equipment, please read and adhere to the following recommendations and all sections of these instructions marked with .

Check the equipment for any transport damage.

A unit that is mechanically damaged or which has been penetrated by liquids or foreign objects must not be connected to the AC power outlet or must be immediately disconnected by unplugging the power cable. Repairs must only be performed by trained personnel in accordance with the applicable regulations.

Should the equipment be delivered without a matching mains cable, the latter has to be prepared by a trained person using the attached female plug (IEC320/C13 or IEC320/C19) with respect to the applicable regulations in your country - see diagram below.

Before connecting the equipment to the AC power outlet, check that the local line voltage matches the equipment rating (voltage, frequency) within the admissible tolerance. The equipment fuses must be rated in accordance with the specifications on the equipment.

Equipment supplied with a 3-pole appliance inlet (equipment conforming to protection class I) must be connected to a 3-pole AC power outlet so that the equipment cabinet is connected to the protective earth conductor of the AC supply (for Denmark the Heavy Current Regulations, Section 107, are applicable).

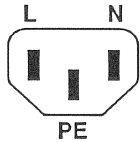
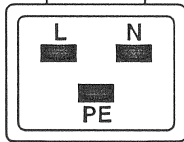
 <p>IEC 320 / C13</p>	 <p>IEC 320 / C19</p>
Female plug (IEC320), view from contact side: L live; brown N neutral; blue PE protective earth; green and yellow	National American Standard: Black White green
Connecteur femelle (IEC320), vue de la face aux contacts: L phase; brun N neutre; bleu PE terre protective; vert et jaune	Standard national américain: Noir Blanc Vert
Ansicht auf Steckkontakte der Kabel-Gerätsteckdose (IEC320): L Phase; braun N Nulleiter; blau PE Schutzleiter; gelb/grün	USA-Standard: Schwarz Weiss grün

### Zugentlastung für den Netzanschluss

Zum Verankern von Steckverbindungen ohne mechanische Verriegelung (z.B. IEC-Kaltgerätedosen) empfehlen wir die folgende Anordnung:

### Mains connector strain relief

For anchoring connectors without a mechanical lock (e.g. IEC mains connectors), we recommend the following arrangement:

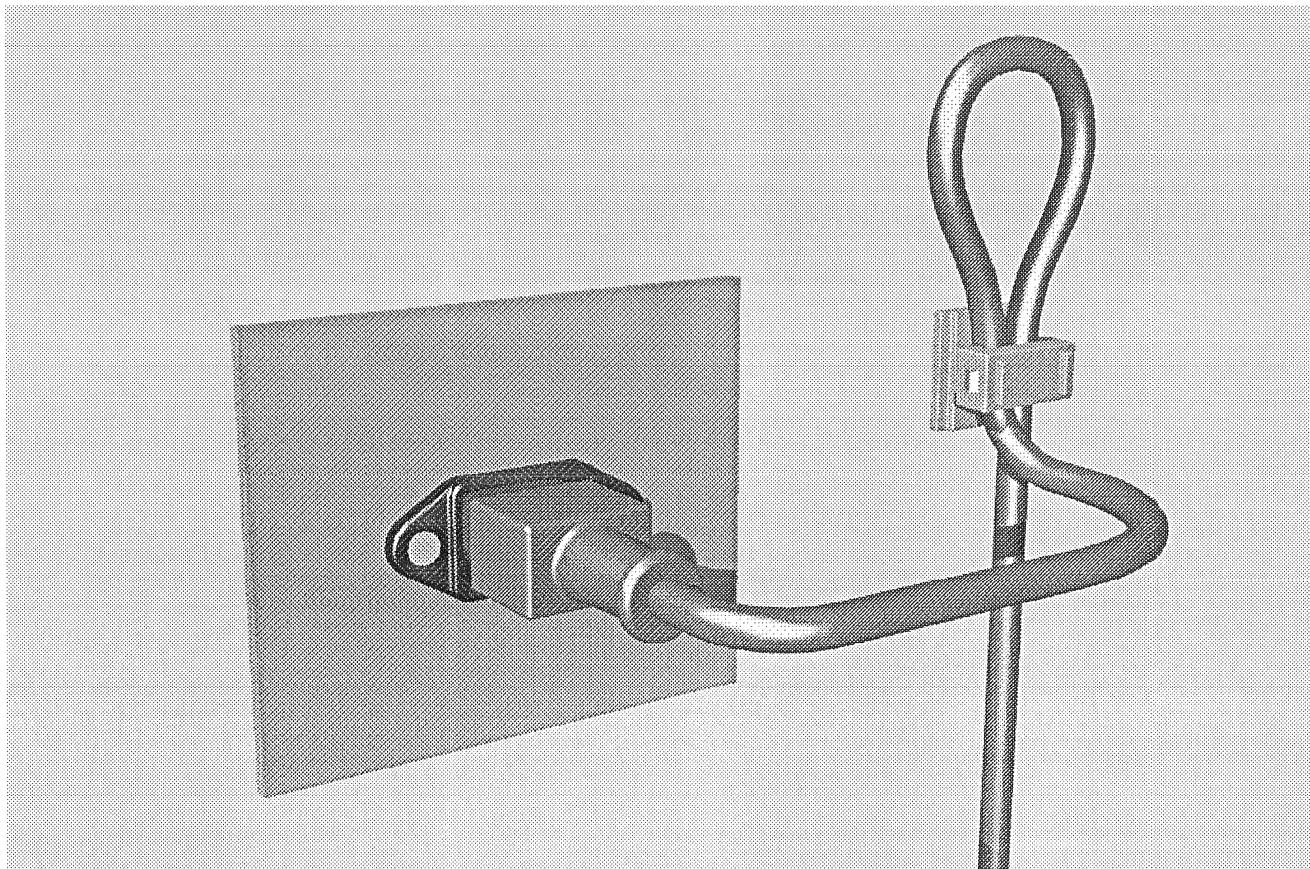

**Vorgehen:** Der mitgelieferte Kabelhalter ist selbstklebend. Bitte beachten Sie bei der Montage die folgenden Regeln:

1. Der Untergrund muss sauber, trocken und frei von Fett, Öl und anderen Verunreinigungen sein. Temperaturbereich für optimale Verklebung: 20...40° C.
2. Entfernen Sie die Schutzfolie auf der Rückseite des Kabelhalters und bringen sie ihn mit kräftigem Druck an der gewünschten Stelle an. Lassen sie ihn unbelastet so lange wie möglich ruhen – die maximale Klebekraft ist erst nach rund 24 Stunden erreicht.
3. Die Stabilität des Kabelhalters wird erhöht, wenn Sie ihn zusätzlich verschrauben. Zu diesem Zweck liegen ihm eine selbstschneidende Schraube sowie eine M4-Schraube mit Mutter bei.
4. Legen Sie das Kabel gemäss Figur in den Halter ein und pressen Sie die Klemme kräftig auf, bis das Kabel fixiert ist.

**Procedure:** The cable clamp shipped with your unit is auto-adhesive. If mounting, please follow the rules below:

1. The surface to be adhered to must be clean, dry, and free from grease, oil or other contaminants. Best application temperature range is 20...40° C.
2. Remove the plastic protective backing from the rear side of the clamp and apply it firmly to the surface at the desired position. Allow as much time as possible for curing. The bond continues to develop for as long as 24 hours.
3. For improved stability, the clamp can be fixed with a screw. For this purpose, a self-tapping screw and an M4 bolt and nut are included.
4. Place the cable into the clamp as shown in the illustration above and firmly press down the internal top cover until the cable is fixed.

## Lufttemperatur und Feuchtigkeit

### Allgemein

Die Betriebstauglichkeit des Gerätes oder Systems ist unter folgenden Umgebungsbedingungen gewährleistet:  
*EN 60721-3-3, Set IE32, Wert 3K3.*

Diese Norm umfasst einen umfassenden Katalog von Parametern; die wichtigsten davon sind: Umgebungstemperatur +5...+40 °C; rel. Luftfeuchtigkeit 5...85% – d.h. weder Kondensation noch Eisbildung; abs. Luftfeuchtigkeit 1...25 g/m<sup>3</sup>; Temperatur-Änderungsrate < 0,5 °C/min. In den folgenden Abschnitten wird darauf näher eingegangen.

Unter den genannten Bedingungen startet und arbeitet das Gerät oder System problemlos. Ausserhalb dieser Spezifikationen möglicherweise auftretende Probleme sind in den folgenden Abschnitten beschrieben.

### Umgebungstemperatur

Geräte und Systeme von Studer sind allgemein für einen Umgebungstemperaturbereich (d.h. Temperatur der eintretenden Kühlluft) von +5...+40 °C ausgelegt. Bei Installation in einem Schrank muss der vorgesehene Luftdurchsatz und dadurch die Konvektionskühlung gewährleistet sein. Folgende Tatsachen sind dabei zu berücksichtigen:

1. Die zulässige Umgebungstemperatur für den Betrieb der Halbleiter-Bauelemente beträgt 0 °C bis +70 °C (commercial temperature range for operation).
2. Der Luftdurchsatz der Anlage muss gewährleisten, dass die austretende Kühlluft ständig kühler ist als 70 °C.
3. Die mittlere Erwärmung der Kühlluft soll 20 K betragen, die maximale Erwärmung an den heissen Komponenten darf somit um weitere 10 K höher liegen.
4. Zum Abführen einer Verlustleistung von 1 kW bei dieser zulässigen mittleren Erwärmung ist eine Luftmenge von 2,65 m<sup>3</sup>/min notwendig.

**Beispiel:** Für ein Rack mit einer Leistungsaufnahme  $P = 800 \text{ W}$  ist eine Kühlluftmenge von  $0,8 * 2,65 \text{ m}^3/\text{min}$  nötig, entsprechend  $2,12 \text{ m}^3/\text{min}$ .

5. Soll die Kühlfunktion der Anlage (z.B. auch bei Lüfter-Ausfall oder Bestrahlung durch Spotlampen) überwacht werden, so ist die Temperatur der Abluft unmittelbar oberhalb der Einschübe an mehreren Stellen im Rack zu messen; die Ansprechtemperatur der Sensoren soll 65 bis 70 °C betragen.

### Reif und Tau

Das unversiegelte System (Steckerpartien, Halbleiteranschlüsse) verträgt zwar leichte Eisbildung (Reif). Mit blossen Auge sichtbare Betauung führt jedoch bereits zu Funktionsstörungen. In der Praxis kann mit einem zuverlässigen Betrieb der Geräte bereits im Temperaturbereich ab -15 °C gerechnet werden, wenn für die Inbetriebnahme des kalten Systems die folgende allgemeine Regel beachtet wird:

Wird die Luft im System abgekühlt, so steigt ihre relative Feuchtigkeit an. Erreicht diese 100%, kommt es zu Niederschlag, meist in der Grenzschicht zwischen der Luft und einer kühleren Oberfläche, und somit zur Bildung von Eis oder Tau an empfindlichen Systemstellen (Kontakte, IC-Anschlüsse etc.). Ein störungsfreier Betrieb mit interner Betauung, unabhängig von der Temperatur, ist nicht gewährleistet.

## Air temperature and humidity

### General

Normal operation of the unit or system is warranted under the following ambient conditions defined by:  
*EN 60721-3-3, set IE32, value 3K3.*

This standard consists of an extensive catalogue of parameters, the most important of which are: ambient temperature +5...+40 °C, relative humidity 5...85% – i.e. no formation of condensation or ice; absolute humidity 1...25 g/m<sup>3</sup>; rate of temperature change < 0,5 °C/min. These parameters are dealt with in the following paragraphs.

Under these conditions the unit or system starts and works without any problem. Beyond these specifications, possible problems are described in the following sections.

### Ambient temperature

Units and systems by Studer are generally designed for an ambient temperature range (i.e. temperature of the incoming air) of +5...+40 °C. When rack mounting the units, the intended air flow and herewith adequate cooling must be provided. The following facts must be considered:

1. The admissible ambient temperature range for operation of the semiconductor components is 0 °C to +70 °C (commercial temperature range for operation).
2. The air flow through the installation must provide that the outgoing air is always cooler than 70 °C.
3. Average heat increase of the cooling air shall be 20 K, allowing for an additional maximum 10 K increase at the hot components.
4. In order to dissipate 1 kW with this admissible average heat increase, an air flow of 2,65 m<sup>3</sup>/min is required.

**Example:** A rack dissipating  $P = 800 \text{ W}$  requires an air flow of  $0,8 * 2,65 \text{ m}^3/\text{min}$  which corresponds to  $2,12 \text{ m}^3/\text{min}$ .

5. If the cooling function of the installation must be monitored (e.g. for fan failure or illumination with spot lamps), the outgoing air temperature must be measured directly above the modules at several places within the rack. The trigger temperature of the sensors should be 65 to 70 °C.

### Frost and dew

The unsealed system parts (connector areas and semiconductor pins) allow for a minute formation of ice or frost. However, formation of dew visible with the naked eye will already lead to malfunctions. In practice, reliable operation can be expected in a temperature range above -15 °C, if the following general rule is considered for putting the cold system into operation:

If the air within the system is cooled down, the relative humidity rises. If it reaches 100%, condensation will arise, usually in the boundary layer between the air and a cooler surface, together with formation of ice or dew at sensitive areas of the system (contacts, IC pins, etc.). Once internal condensation occurs, troublefree operation cannot be guaranteed, independent of temperature.

Vor der Inbetriebnahme muss das System auf allfällige interne Betauung oder Eisbildung überprüft werden. Nur bei sehr leichter Eisbildung kann mit direkter Verdunstung (Sublimation) gerechnet werden; andernfalls muss das System im abgeschalteten Zustand gewärmt und getrocknet werden.

Das System ohne feststellbare interne Eisbildung oder Betauung soll möglichst homogen (und somit langsam) mit eigener Wärmeleistung aufgewärmt werden; die Lufttemperatur der Umgebung soll ständig etwas tiefer als diejenige der Systemluft sein.

Ist es unumgänglich, das abgekühlte System sofort in warmer Umgebungsluft zu betreiben, so muss diese entfeuchtet sein. Die absolute Luftfeuchtigkeit muss dabei so tief sein, dass die relative Feuchtigkeit, bezogen auf die kälteste Oberfläche im System, immer unterhalb 100% bleibt.

Es ist dafür zu sorgen, dass beim Abschalten des Systems die eingeschlossene Luft möglichst trocken ist (d.h. vor dem Abschalten im Winter den Raum mit kalter, trockener Luft belüften und feuchte Gegenstände, z.B. Kleider, entfernen).

Die Zusammenhänge sind im folgenden Klimatogramm ersichtlich. Zum kontrollierten Verfahren gehören Thermometer und Hygrometer sowie ein Thermometer innerhalb des Systems.

**Beispiel 1:** Ein Ü-Wagen mit einer Innentemperatur von 20 °C und 40% relativer Luftfeuchtigkeit wird am Abend abgeschaltet. Sinkt die Temperatur unter +5 °C, bildet sich Tau oder Eis.

**Beispiel 2:** Ein Ü-Wagen wird morgens mit 20 °C warmer Luft von 40% relativer Luftfeuchtigkeit aufgewärmt. Auf Teilen, die kälter als +5 °C sind, bildet sich Tau oder Eis.

Before putting into operation, the system must be checked for internal formation of condensation or ice. Only with a minute formation of ice, direct evaporation (sublimation) may be expected; otherwise the system must be heated and dried while switched off.

A system without visible internal formation of ice or condensation should be heated up with its own heat dissipation, as homogeneously (and subsequently as slow) as possible; the ambient temperature should then always be lower than the outgoing air.

If it is absolutely necessary to operate the system immediately within warm ambient air, this air must be dehydrated. In such a case, the absolute humidity must be so low that the relative humidity, related to the coldest system surface, always remains below 100%.

Ensure that the enclosed air is as dry as possible when powering off (i.e. before switching off in winter, aerate the room with cold, dry air, and remove humid objects as clothes from the room).

These relationships are visible from the following climatogram. For a controlled procedure, thermometer and hygrometer as well as a thermometer within the system will be required.

**Example 1:** An OB-van having an internal temperature of 20 °C and rel. humidity of 40% is switched off in the evening. If temperature falls below +5 °C, dew or ice will be forming.

**Example 2:** An OB-van is heated up in the morning with air of 20 °C and a rel. humidity of 40%. On all parts being cooler than +5 °C, dew or ice will be forming.

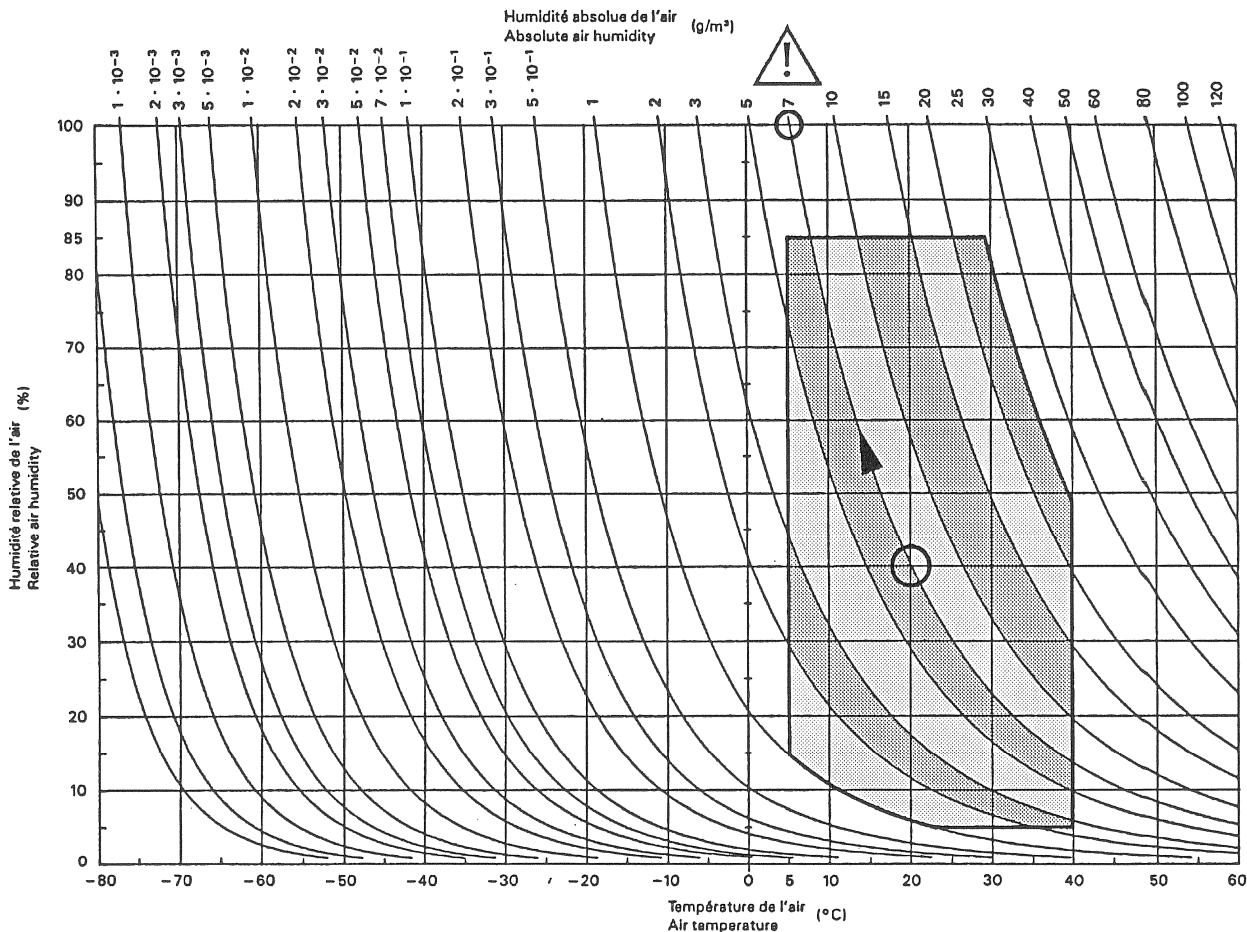

Figure B.3 – Climatogramme pour catégorie 3K3  
Climatogram for class 3K3



## Wartung und Reparatur

Durch Entfernen von Gehäuseteilen, Abschirmungen etc. werden stromführende Teile freigelegt. Deshalb müssen u.a. die folgenden Grundsätze beachtet werden: Eingriffe in das Gerät dürfen nur von Fachpersonal unter Einhaltung der geltenden Vorschriften vorgenommen werden.

Vor Entfernen von Gehäuseteilen muss das Gerät ausgeschaltet und vom Netz getrennt werden.

Bei geöffnetem, vom Netz getrenntem Gerät dürfen Teile mit gefährlichen Ladungen (z. B. Kondensatoren, Bildröhren) erst nach kontrollierter Entladung, heiße Bauteile (Leistungshalbleiter, Kühlkörper etc.) erst nach deren Abkühlen berührt werden.

Bei Wartungsarbeiten am geöffneten, unter Netzspannung stehenden Gerät dürfen blanke Schaltungs- teile und metallene Halbleitergehäuse weder direkt noch mit nichtisoliertem Werkzeug berührt werden.

Zusätzliche Gefahren bestehen bei unsachgemäßer Handhabung besonderer Komponenten:

- *Explosionsgefahr* bei Lithiumzellen, Elektrolyt-Kondensatoren und Leistungshalbleitern
- *Implosionsgefahr* bei evakuierten Anzeigeeinheiten
- *Strahlungsgefahr* bei Lasereinheiten (nichtionisierend), Bildröhren (ionisierend)
- *Verätzungsgefahr* bei Anzeigeeinheiten (LCD) und Komponenten mit flüssigem Elektrolyt.

*Solche Komponenten dürfen nur von ausgebildetem Fachpersonal mit den vorgeschriebenen Schutzmitteln (u.a. Schutzbrille, Handschuhe) gehandhabt werden.*

## Maintenance and Repair

The removal of housing parts, shields, etc. exposes energized parts. For this reason the following precautions should be observed:

Maintenance should only be performed by trained personnel in accordance with the applicable regulations.

The equipment should be switched off and disconnected from the AC power outlet before any housing parts are removed.

Even if the equipment is disconnected from the power, parts with hazardous charges (e.g. capacitors, picture tubes) must not be touched until they have been properly discharged. Touch hot components (power semiconductors, heat sinks, etc.) only when cooled off.

If maintenance is performed on a unit that is opened and switched on, no uninsulated circuit components and metallic semiconductor housings must be touched neither with your bare hands nor with uninsulated tools.

Certain components pose additional hazards:

- *Explosion hazard* from lithium batteries, electrolytic capacitors and power semiconductors
- *Implosion hazard* from evacuated display units
- *Radiation hazard* from laser units (non-ionizing), picture tubes (ionizing)
- *Caustic effect* of display units (LCD) and such components containig liquid electrolyte.

*Such components should only be handled by trained personnel who are properly protected (e.g. safety goggles, gloves).*

**Elektrostatische Entladung (ESD)  
bei Wartung und Reparatur**

**Electrostatic Discharge (ESD)  
during Maintenance and Repair**

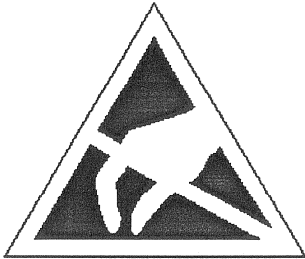

- ATTENTION:** Observe precautions for handling devices sensitive to electrostatic discharge!
- ATTENTION:** Respecter les précautions d'usage concernant la manipulation de composants sensibles à l'électricité statique!
- ACHTUNG:** Vorsichtsmassnahmen bei Handhabung elektrostatisch entladungsgefährdeter Bauelemente beachten!

Viele ICs und andere Halbleiter sind empfindlich gegen elektrostatische Entladung (ESD). Unfachgerechte Behandlung von Baugruppen mit solchen Komponenten bei Wartung und Reparatur kann deren Lebensdauer drastisch vermindern.

Bei der Handhabung der ESD-empfindlichen Komponenten sind u.a. folgende Regeln zu beachten:

- ESD-empfindliche Komponenten dürfen ausschliesslich in dafür bestimmten und bezeichneten Verpackungen gelagert und transportiert werden.
- Unverpackte, ESD-empfindliche Komponenten dürfen nur in dafür eingerichteten Schutzzonen (EPA, z.B. Gebiet für Feldservice, Reparatur- oder Serviceplatz) gehandhabt und nur von Personen berührt werden, die durch ein Handgelenkband mit Serienwiderstand mit dem Massepotential des Reparatur- oder Serviceplatzes verbunden sind. Das gewartete Gerät wie auch Werkzeug, Hilfsmittel, EPA-taugliche (elektrisch halbleitende) Arbeits-, Ablage- und Bodenmatten müssen ebenfalls mit diesem Potential verbunden sein.
- Die Anschlüsse der ESD-empfindlichen Komponenten dürfen unkontrolliert weder mit elektrostatisch aufladbaren (Gefahr von Spannungsdurchschlag), noch mit metallischen Oberflächen (Schockentladungsgefahr) in Berührung kommen.
- Um undefinierte transiente Beanspruchung der Komponenten und deren eventuelle Beschädigung durch unerlaubte Spannung oder Ausgleichsströme zu vermeiden, dürfen elektrische Verbindungen nur am abgeschalteten Gerät und nach dem Abbau allfälliger Kondensatorladungen hergestellt oder getrennt werden.

Many ICs and semiconductors are sensitive to electrostatic discharge (ESD). The life of components containing such elements can be drastically reduced by improper handling during maintenance and repair work.

Please observe the following rules when handling ESD sensitive components:

- ESD sensitive components should only be stored and transported in the packing material specifically provided for this purpose.
- Unpacked ESD sensitive components should only be handled in ESD protected areas (EPA, e.g. area for field service, repair or service bench) and only be touched by persons who wear a wristlet that is connected to the ground potential of the repair or service bench by a series resistor. The equipment to be repaired or serviced and all tools, aids, as well as electrically semiconducting work, storage and floor mats should also be connected to this ground potential.
- The terminals of ESD sensitive components must not come in uncontrolled contact with electrostatically chargeable (voltage puncture) or metallic surfaces (discharge shock hazard).
- To prevent undefined transient stress of the components and possible damage due to inadmissible voltages or compensation currents, electrical connections should only be established or separated when the equipment is switched off and after any capacitor charges have decayed.

**SMD-Bauelemente**

**SMD Components**

Der Austausch von SMD-Bauelementen ist ausschliesslich geübten Fachleuten vorbehalten. Für verwüstete Platinen können keine Ersatzansprüche geltend gemacht werden. Beispiele für korrekte und falsche SMD-Lötverbindungen in der Abbildung weiter unten.

SMDs should only be replaced by skilled specialists. No warranty claims will be accepted for circuit boards that have been ruined. Proper and improper SMD soldering joints are depicted below.

Bei Studer werden keine handelsüblichen SMD-Teile bewirtschaftet. Für Reparaturen sind die notwendigen Bauteile lokal zu beschaffen. Die Spezifikationen von Spezialbauteilen finden Sie in der Serviceanleitung.

Studer does not keep any commercially available SMDs in stock. For repair the corresponding devices should be purchased locally. The specifications of special components can be found in the service manual.

<p><b>Demontage/Dismounting</b></p>			
<p><b>Montage/Mounting</b></p>		<p><b>Beispiele/Examples</b></p>	

## Störstrahlung und Störfestigkeit

Das Gerät entspricht den Schutzanforderungen auf dem Gebiet elektromagnetischer Phänomene, wie u.a. in den Richtlinien 89/336/EWG und FCC, Part 15, aufgeführt:

1. Vom Gerät erzeugte elektromagnetische Strahlung ist soweit begrenzt, dass bestimmungsgemässer Betrieb anderer Geräte und Systeme möglich ist.
2. Das Gerät weist eine angemessene Festigkeit gegen elektromagnetische Störungen auf, so dass sein bestimmungsgemässer Betrieb möglich ist.

Das Gerät wurde getestet und erfüllt die Bedingungen der im Kapitel „Technische Daten“ aufgeführten EMV-Standards. Die Limiten dieser Standards gewährleisten mit angemessener Wahrscheinlichkeit sowohl den Schutz der Umgebung wie auch entsprechende Störfestigkeit des Gerätes. Absolute Garantie, dass keine unerlaubte elektromagnetische Beeinträchtigung während des Betriebes entsteht, ist jedoch nicht gegeben.

Um die Wahrscheinlichkeit solcher Beeinträchtigung weitgehend auszuschliessen, sind u.a. folgende Massnahmen zu beachten:

- Installieren Sie das Gerät gemäss den Angaben in der Betriebsanleitung, und verwenden Sie das mitgelieferte Zubehör.
- Verwenden Sie im System und in der Umgebung, in denen das Gerät eingesetzt ist, nur Komponenten (Anlagen, Geräte), die ihrerseits die Anforderungen der obenerwähnten Standards erfüllen.
- Sehen Sie ein Erdungskonzept des Systems vor, das sowohl die Sicherheitsanforderungen (die Erdung der Geräte gemäss Schutzklasse I mit einem Schutzleiter muss gewährleistet sein), wie auch die EMV-Belange berücksichtigt. Bei der Entscheidung zwischen stern- oder flächenförmiger bzw. kombinierter Erdung sind Vor- und Nachteile gegeneinander abzuwägen.
- Benutzen Sie abgeschirmte Kabel, wo vorgesehen. Achten Sie auf einwandfreie, grossflächige, korrosionsbeständige Verbindung der Abschirmung zum entsprechenden Steckeranschluss und dessen Gehäuse. Beachten Sie, dass eine nur an einem Ende angeschlossene Kabelabschirmung als Sende- bzw. Empfangsantenne wirken kann (z.B. bei wirksamer Kabellänge von 5 m oberhalb von 10 MHz), und dass die Flanken digitaler Kommunikationssignale hochfrequente Aussendungen verursachen (z.B. LS- oder HC-Logik bis 30 MHz).
- Vermeiden Sie Bildung von Masseschleifen oder vermindern Sie deren unerwünschte Auswirkung, indem Sie deren Fläche möglichst klein halten und den darin fließenden Strom durch Einfügen einer Impedanz (z.B. Gleichtaktdrossel) reduzieren.

## Electromagnetic Compatibility

The equipment conforms to the protection requirements relevant to electromagnetic phenomena that are listed in the guidelines 89/336/EC and FCC, part 15.

1. The electromagnetic interference generated by the equipment is limited in such a way that other equipment and systems can be operated normally.
2. The equipment is adequately protected against electromagnetic interference so that it can operate correctly.

The unit has been tested and conforms to the EMC standards applicable to residential, commercial and light industry, as listed in the section „Technical Data“. The limits of these standards reasonably ensure protection of the environment and corresponding noise immunity of the equipment. However, it is not absolutely warranted that the equipment will not be adversely affected by electromagnetic interference during operation.

To minimize the probability of electromagnetic interference as far as possible, the following recommendations should be followed:

- Install the equipment in accordance with the operating instructions. Use the supplied accessories.
- In the system and in the vicinity where the equipment is installed, use only components (systems, equipment) that also fulfill the above EMC standards.
- Use a system grounding concept that satisfies the safety requirements (protection class I equipment must be connected with a protective ground conductor) that also takes into consideration the EMC requirements. When deciding between radial, surface or combined grounding, the advantages and disadvantages should be carefully evaluated in each case.
- Use shielded cables where shielding is specified. The connection of the shield to the corresponding connector terminal or housing should have a large surface and be corrosion-proof. Please note that a cable shield connected only single-ended can act as a transmitting or receiving antenna (e.g. with an effective cable length of 5 m, the frequency is above 10 MHz) and that the edges of the digital communication signals cause high-frequency radiation (e.g. LS or HC logic up to 30 MHz).
- Avoid ground loops or reduce their adverse effects by keeping the loop surface as small as possible, and reduce the noise current flowing through the loop by inserting an additional impedance (e.g. common-mode rejection choke).

## Class A Equipment - FCC Notice

This equipment has been tested and found to comply with the limits for a Class A digital device, pursuant to Part 15 of the FCC Rules. These limits are designed to provide a reasonable protection against harmful interference when the equipment is operated in a commercial environment. This equipment generates, uses, and can radiate radio frequency energy and, if not installed and used in accordance with the instruction manual, may cause harmful interference to radio communications. Operation of this equipment in a residen-

tial area is likely to cause harmful interference in which case the user will be required to correct the interference at his own expense.

*Caution:*

*Any changes or modifications not expressly approved by the manufacturer could void the user's authority to operate the equipment. Also refer to relevant information in this manual.*

## CE-Konformitätserklärung

Der Hersteller,

Studer Professional Audio AG,  
CH-8105 Regensdorf,

erklärt in eigener Verantwortung, dass das Produkt

**Studer A827, professionelles Mehrkanal-Bandgerät,  
(ab Serie-Nr. 1664),**

auf das sich diese Erklärung bezieht, entsprechend den Bestimmungen der EU-Richtlinien und Ergänzungen

- Elektromagnetische Verträglichkeit (EMV):  
89/336/EWG + 92/31/EWG + 93/68/EWG
- Niederspannung:  
73/23/EWG + 93/68/EWG

mit den folgenden Normen und normativen Dokumenten übereinstimmt:

- Sicherheit:  
Schutzklasse I, EN 60065:1993; IEC 65:1985
- EMV:  
EN 50081-1:1992, EN 50082-1:1992.

Regensdorf, 16. Juni 1995



B. Hochstrasser, Geschäftsleiter



P. Fiala, Leiter QS

## CE Declaration of Conformity

The manufacturer,

Studer Professional Audio AG,  
CH-8105 Regensdorf,

declares under his sole responsibility that the product

**Studer A827, professional multichannel tape recorder,  
(on from serial No. 1664),**

to which this declaration relates, according to following regulations of EU directives and amendments

- Electromagnetic Compatibility (EMC):  
89/336/EEC + 92/31/EEC + 93/68/EEC
- Low Voltage (LVD):  
73/23/EEC + 93/68/EEC

is in conformity with the following standards or other normative documents:

- Safety:  
Class I, EN 60065:1993; IEC 65:1985
- EMC:  
EN 50081-1:1992, EN 50082-1:1992.

Regensdorf, June 16, 1995



B. Hochstrasser, Managing director



P. Fiala, Manager QA

## Contents

---

<b>1</b>	<b>Installation, operation</b>	<b>1</b>
1.1	Salient features of the A827 MCH	1
1.2	Unpacking and testing of the equipment	3
1.3	Installation site	3
1.4	Power switch	3
1.5	Operation of the A827 MCH	7
1.5.1	Operator surface	7
1.5.2	VU-meter penthouse and monitor speaker	7
1.6	Operation	8
1.6.1	Feedback lamps	8
1.6.2	Threading the tape	9
1.6.3	Tape speeds	9
1.6.4	Play	9
1.6.5	Reverse play	10
1.6.6	Varispeed	10
1.6.7	Record	10
1.6.8	Spooling	11
1.6.9	Stop	11
1.6.10	Editing, tape splicing	12
1.6.11	Dump edit mode (tape dump)	12
1.6.12	Locator	14
1.6.13	Tape timer	15
1.6.14	LAP tape timer	15
1.6.15	Parallel remote control	16
1.6.16	Time code channel	17
1.7	Menu tree, soft keys	18
1.7.1	Entering the menu tree	18
1.7.2	The tree main branches	19
	<b>Description of the menu windows in the:</b>	
1.7.3	- audio setup branch	26
1.7.4	- time code setup branch	27
1.7.5	- tape deck setup branch	28
1.7.6	- audio key and function programming branch	29
1.7.7	- audio key programming branch	32
1.7.8	- tape deck key and function programming branch	32
1.7.9	- tape deck key programming branch	36
1.7.10	Tree Diagram	42

### Operating aid:

In the appendix of these operating instructions you will find an overview card of the menu tree. All valid soft settings of the A827 MCH are conveniently listed on this card.

<b>1.8</b>	<b>Operating the audio remote control</b>	<b>46</b>
1.8.1	Introduction	46
1.8.2	Connecting the audio remote control to the A827 MCH	46
1.8.3	Operator controls and status indicators	44
1.8.4	Basic tape deck functions	46
1.8.5	Keypad for the functions LOCATE, LOOP and RESET	46
1.8.6	Keypad for the varispeed functions	47
1.8.7	Keypad for storing various channel settings	48
1.8.8	Keys for the monitor mode functions	49
1.8.9	Keys for the record mode functions	49
1.8.10	Indicator LEDs for tape flux and Dolby HX	50
1.8.11	ALL keys (Master)	50
1.8.12	Individual channel and output selection keys	52
<b>1.9</b>	<b>Operation with degraded performance</b>	<b>53</b>
1.9.1	Error messages on the service display	53
1.9.2	Error category breakdown via the RS232 (ASCII interface)	59
<b>1.10</b>	<b>Operation with the serial interface</b>	<b>60</b>
1.10.1	SMPTE/EBU bus	60
1.10.2	RS232 interface	60
1.10.3	Serial ASCII interface of the A827 MCH 1.810.751	61
<b>1.11</b>	<b>Storing the audio parameters</b>	<b>62</b>
1.11.1	Saving the data on the A827 MCH without cable	62
1.11.2	Data backup via cable on the A827 MCH or on an external tape recorder	65
<b>2</b>	<b>Technical Information</b>	<b>68</b>
<b>2.1</b>	<b>Connections</b>	<b>68</b>
2.1.1	Mains Connection, Mains Voltage Selector	69
2.1.2	Audio Parallel If	70
2.1.3	Audio Remote	73
2.1.4	Parallel Remote	75
2.1.5	External synchronizer connector	77
2.1.6	Autolocator/Timer	78
2.1.7	RS232C port (ASCII coded) 1.810.751 SMPTE/EBU port RS422/RS232C (binary coded) 1.820.751	79
2.1.8	Noise Reduction System	80
2.1.9	Time Code Slave IN/OUT	81
2.1.10	Time Code Master IN/OUT	81
2.1.11	Parallel Remote	82
2.1.12	LCU	83
2.1.13	Serial Remote	83
2.1.14	Master Tallies	84
2.1.15	Composite Video IN/OUT	85
2.1.16	Line Input and Output	85
2.1.17	Sync Out (Asymmetrisch)	86

<b>2.2 Jumper Array.....</b>	<b>87</b>
<b>2.3 Installation of the Serial ASCII Interface 1.810.751.....</b>	<b>90</b>
2.3.1 Command Protocol Explanations .....	90
<b>2.4 Installation of the Serial Interface 1.820.751 (SMPTF/FRII) .....</b>	<b>102</b>
<b>2.5 How to Perform a Software Update .....</b>	<b>106</b>
<b>2.6 Technical Data .....</b>	<b>112</b>
2.6.1 General Data.....	112
2.6.2 Electrical Data (Preliminary Data).....	113
2.6.3 Standard Calibration Data .....	117
<b>3 Standard Versions and Accessories.....</b>	<b>118</b>
<b>3.1 Standard Versions .....</b>	<b>118</b>
<b>3.2 Accessories .....</b>	<b>118</b>
<b>3.3 Options.....</b>	<b>119</b>
<b>3.4 Remote Control Stands.....</b>	<b>120</b>
<b>4 Care Instructions.....</b>	<b>121</b>
<b>4.1 Components Sensitive to Electrostatic Charges .....</b>	<b>122</b>



# 1 Installation, operation

## 1.1 Salient features of the A827 MCH

Due to its compact and extremely sturdy design, its variety of available interfaces, and the exceptional operating convenience provided by multiple micro-processors, the A827 MCH is eminently suited for applications in broadcasting or television, in film and recording studios, in theaters, and in scientific institutes. This tape machine satisfies the exacting requirements of sophisticated recording studios and synchronization systems.

### Its salient features are:

- Tape deck:**
- Extremely stable die-cast aluminum alloy parts for the tape deck chassis, the headblock, the pinch roller assembly, the tape guide roller assembly and the headblock.
  - Quartz-controlled, Hall-commutated DC capstan motor with quartz reference and capacitive speed and direction sensing for highly accurate tape speed and fast acceleration and deceleration.
  - Reverse play and reverse record are feasible.
  - Agile tape deck with high spooling speed (up to 15 m/sec). Electronically controlled tape tension, servo-controlled DC disc rotor motors with photo-electric speed and rotation direction sensing, non-wearing tape tension sensors. Clocked, high-efficiency spooling motor drive with minimal power dissipation.
  - Easy editing: Variable spooling speed; the high frequencies are lowered while cueing in spooling mode. The tape tension control circuit is also active in STOP mode so that one-handed tape shuttling is possible by turning either spindle.
  - Manually operable head shield in front of the record and reproduce heads.
  - Splicing rail on the headblock cover.
  - Max. reel capacity 356 mm (14"). Operation with different reel sizes possible because of the automatic inertia sensing.
  - Accurate electronic tape counter with real-time indication for all tape speeds, positive and negative time indication, zero locator and address locator for up to 5 addresses.
  - In varispeed mode, the tape speed can be adjusted from -35.15% to +54.21% ( $\pm 7.5$  halftones), relative to the selected nominal speed.
  - Line voltage selector switch for 100, 120, 140, 200, 220 and 240 VAC  $\pm 10\%$ , 50 ... 60 Hz.
- Audio:**
- The standard model is available as an 8-channel/1", 16-channel/2", or 24-channel/2" machine.
  - 16- and 24-channel machines can be converted to 8 channels by means of a special kit.
  - 16-Channel machines can be converted to 24 channels by exchanging the headblock and by expanding the audio electronics to 24 channels.
  - Each headblock features an electronic index that ensures that all tape deck and audio parameters previously set for this headblock are automatically reestablished. This means that no recalibration is necessary after the conversion from 24 to 16 or 8 channels.
  - The parameter memories can hold the information for two different tape types and for each of the three possible headblocks (8, 16- and 24-channels).

- Selectable nominal level.
- Standard the A827MCH is equipped with the Dolby HX PRO system.
- Three selectable nominal tape speeds (7.5 / 15 / 30 ips).
- Balanced and floating inputs with transformers; the outputs are electronically balanced.
- Connectors for fader start, parallel and serial remote control, NRS, audio remote control and partially equalized SYNC outputs.

- Operator facilities:** Maximum operating convenience due to multiprocessor architecture.
- The tape timer content, the locator addresses, the audio parameters and the tape speed are saved when the machine is switched off. STOP and SAFE are automatically set when the machine is switched off.
  - Various drop-in versions can be programmed.
  - Drop-out by pressing PLAY in record mode.
  - Reduced spooling speed (LIBRARY WIND) for producing smoother library pancakes.
  - Zero-locator: Automatic search of the tape address 0.00.00 (tape timer).
  - Transfer locators LOC 1 ... LOC 5: for storing five tape addresses that can be automatically searched. The addresses can be displayed without activating the locate function.
  - Programmable keys (soft keys): Each key can be assigned to any of approx. 100 available functions (see list in Section 1.7).
  - Internal standard testing system for the main functions, with plain-text error messages.
  - Convenient parameter input via the LC display eliminates the need for time-consuming setup with trimmer potentiometers.
  - Built-in audio generator for audio alignment (option).
  - All parameters can be saved on tape via a biphas interface.

- Remote control systems:** Various solutions are supported by the flexible interfaces:
- Parallel tape deck and synchronizer interface, identical with the STUDER A807, A812, and A820 machines.
  - Serial interfaces for autolocator, tape deck control, remote counter and channel remote control.
  - NRS interface for controlling an external noise reduction system (Dolby or Telcom).
- Available as options:
- Serial RS 232 interface according to ASCII protocol.
  - RS 422 interface with binary protocol according to SMPTE/EBU standard, switchable to RS 232 with identical protocol.
  - STUDER TLS 4000 synchronizer.

- Maintenance:**
- Very easy to service due to the modular design and tiltable transport chassis.
  - All PC boards are easily accessible
  - All ICs are socket mounted.
  - No recalibration required when electronic or mechanical assemblies are replaced.

## 1.2 Unpacking and testing of the equipment

The A827 MCH tape recorder is delivered in a special packing that protects it from damage in transit. Care should be exercised when unpacking the recorder so that the equipment surfaces will not become marred.

Compare the content with the packing slip to ensure that the equipment is complete. Save the original packing material because it provides the best protection to your recorder for subsequent shipment.

Examine the complete content for possible shipping damage.

The shipping company and the nearest STUDER dealer should be notified immediately if any damage is noticed.

## 1.3 Installation site

The A827 MCH tape recorder should be installed in a dust-free, well ventilated location. The recorder specifications are guaranteed for ambient temperatures ranging from 0°C to 40°C. The relative humidity (noncondensing) should be between 20% and 90%.

Install the recorder in a place where there is sufficient space for unobstructed ventilation. Localization of heat can occur when the recorder is installed in a recess. The air circulation zone should not be used as a storage area. The recorder should not be placed in close proximity to strong electromagnetic fields. General sources of interference are: strong load fluctuations on adjacent power lines, high-power transformers, elevator motors, as well as nearby radio and television transmitters.

The back of the recorder should remain accessible for service purposes.

## 1.4 Power switch

**CAUTION!** Before your switch on the tape recorder for the first time, make sure that the line voltage selector, on the front of the equipment agree with the local line voltage. For changing the switch setting refer to Section 2.1.1. The power switch is located at the bottom right of the front panel.

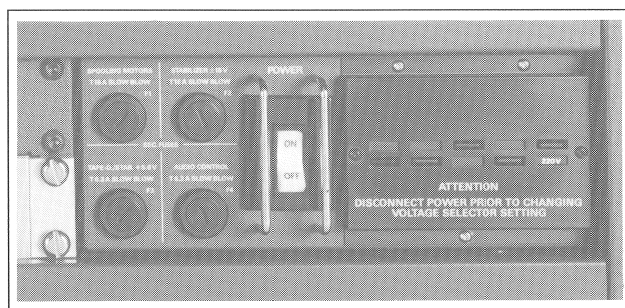
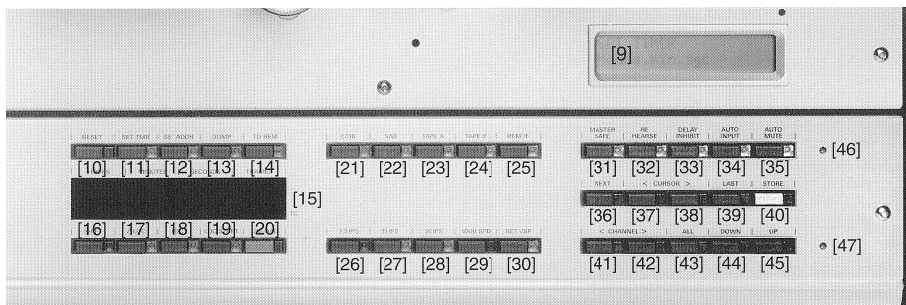
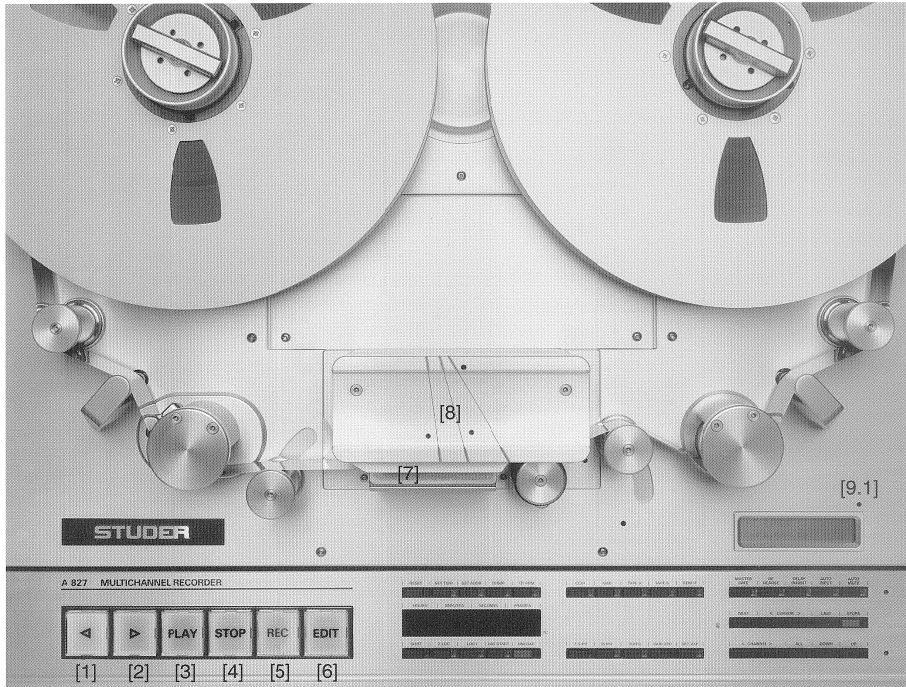

Fig. 1.4.1 Mains Switch voltage selector and fuses

1.5 Operation of the A827 MCH

1.5.1 Operator surface



**Note:** The channel selection functions are located on the audio remote, see Section 1.8.

- [1] ◀ Fast forward
- [2] ▶ Fast rewind
- [3] PLAY Play mode
- [4] STOP Interrupts all tape transport functions. Stored locator addresses and Tape A/B, CCIR, NAB functions can be displayed by simultaneously pressing STOP and LOC1...5 or LOCSTART.
- [5] REC Record mode. Starts the record function when pressed together with PLAY. (Precondition: channel to be recorded is switched to ready). Depending on the programming, record can be activated directly from PLAY mode by pressing either the REC key alone (F308: RECORD B) or by pressing PLAY + REC (F307: RECORD A).
- [6] EDIT Edit function for one-handed cueing, i.e. the tape can be positioned by turning one of the two spindles.
- [7] Head shield Shields the soundheads against parasitic electromagnetic fields. Can be closed or opened manually.
- [8] Splicing rail For convenient editing of the tapes.
- [9] LC display Alphanumeric liquid-crystal display for indicating the software state, speed deviation in varispeed mode, error messages, and for programming the tape deck parameters etc.
- [9.1] Brightness control Slotted screw for adjusting the brightness of the LC display
- [10] RESET Reset key for the tape timer.
- [11] SET TIMER
  - A known tape address can be entered into the tape timer via the cursor keypad.
  - Save the address by pressing STORE.
- [12] SET ADDR
  - A tape address can be entered into the locator memory via the cursor keypad.
  - Save the address by simultaneously pressing SHIFT and the desired LOC key.
- [13] DUMP Dump edit mode. Four programmable possibilities:
  - TAPE DUMP-A: Tape timer ON (F327)
  - TAPE DUMP-B: Tape timer OFF (F328)
  - TAPE DUMP-C: Tape timer ON, preselection key, activate with PLAY (F329)
  - TAPE DUMP-D: Tape timer OFF, preselection key, activate with PLAY (F330)
- [14] TD REM Activates the tape deck remote control, the local keyboard can be switch on or off (see Section 1.7, F345 REM A and F346 REM B).
- [15] Tape timer LED display for tape counter. Real-time counter for all tape speeds showing hours, minutes and seconds; switchable to displaying a second counter with user-selectable reference (LAP).

**[16] SHIFT**

- Preselection key for transferring a tape address into one of the five memory locations.
- The actual address is stored by pressing SHIFT + LOC1...LOC5.

Key actuation	Function
SHIFT + LOC 1...5	Transfers the displayed tape address into the corresponding LOC memory
SHIFT + PLAY	Reverse play
SHIFT + REC	Reverse record
Shift + ◀/▶	Library wind (spooling with reduced speed)

**[17] Z-LOC**

The tape address corresponding to the counter reading 0.00.00 is automatically searched. Relates to the actual zero position in normal operation as well as in LAP mode.

**[18] LOC 1**

The stored address is automatically searched. The LOCATE address is displayed for as long as this key is pressed.

**[19] LOC START**

Automatic search of the tape address at which the last PLAY or REC command (with tape standing still) has been entered. Depending on the programming, the machine then switches to PLAY, STOP or RECORD (F319-321).

**[20] UNLOAD**

Key for retracting the pinch roller assembly into the normal position.

**[21] CCIR**

When pressed together with the STOP key: Changeover of the equalization to CCIR standard.

**[22] NAB**

When pressed together with the STOP key: Changeover of the equalization to NAB standard.

**[23] TAPE A**

When pressed simultaneously with the STOP key: Changeover to tape type A.

**[24] TAPE B**

When pressed simultaneously with the STOP key: Changeover to tape type B.

**[25] REM IF**

Enables the 9-pin connector for a parallel audio selection box

**[26] 7.5 IPS**

Tape speed selection 7.5 ips (19 cm/s)

**[27] 15 ips**

Tape speed selection 15 ips (38 cm/s)

**[28] 30 ips**

Tape speed selection 30 ips (76 cm/s)

**[29] VARI SPD:**

On/off switch for variable tape speed

**[30] SET VSP:**

Key for enabling the variable tape speed. The speed can be adjusted with the UP/DOWN key.

- [31] MASTER SAFE:** Record inhibition, switches all channels to SAFE and consequently protects them against unintentional erasure. The READY function of the audio remote control is disabled.
- [32] REHEARSE:** Simulates an electronic edit operation. The PLAY and REC keys flash in play mode. Switch the channels to SYNC and READY, for making a recording simply press INPUT.  
Note: DELAY INHIBIT should not be active.
- [33] DELAY INHIBIT:** Tape travel time compensation. Delays the activation/deactivation of the record head (relative to the erase head) when the drop-in/drop-out occurs. When this function is selected (i.e. the LED is light), the tape travel time compensation is switched off. DELAY INHIBIT should not be active in conjunction with the REHEARSE FUNCTION.
- [34] AUTO INPUT:** In the operating modes STOP, REWIND, FORWARD, LOC and ROLLBACK, all channels switched to SYNC (F052: AUTO INPUT A) or SYNC and READY (AUTO INPUT B) are switched to INPUT.  
Standard setting: AUTO INPUT B.
- [35] AUTO MUTE:** Automatic muting:
- During the acceleration phase until the nominal tape speed is attained.
  - In spooling mode.
  - After STOP has been pressed.
- Exception:** Tape lift pin pressed to enable cueing.
- [36] NEXT:**  
**[37] CURSOR/<:**  
**[38] CURSOR/>:**  
**[39] LAST:**
- } Keys for paging in the menu and for navigating the cursor on the service display.
- [40] STORE:** Multifunction key:
- For storing changed tape deck and audio parameters.
  - For changing over a function that is not assigned to any key.
  - For reprogramming a key function (when pressed together with the corresponding key).
  - For acknowledging an error message.
- [41] CHANNEL <:** Channel selection in the audio alignment programming branch (numerically descending)
- [42] CHANNEL >:** Channel selection in the audio alignment programming branch (numerically ascending)
- [43] ALL:**  
**[44] DOWN:**  
**[45] UP:**
- } Selection of all channels for joint audio calibration  
Increasing/decreasing of parameter values
- [46] Enable key** The enable switch (PROGRAM ENABLE) permits access to the software menu. To prevent inadvertent modification of parameters, this button must be pressed with a thin object.  
With "F247: Program disable A/B" it is possible to locate the program enable function in two different locations of the software menu.
- [47] Dummy key** No function

## 1.5.2 VU-meter penthouse and monitor speaker

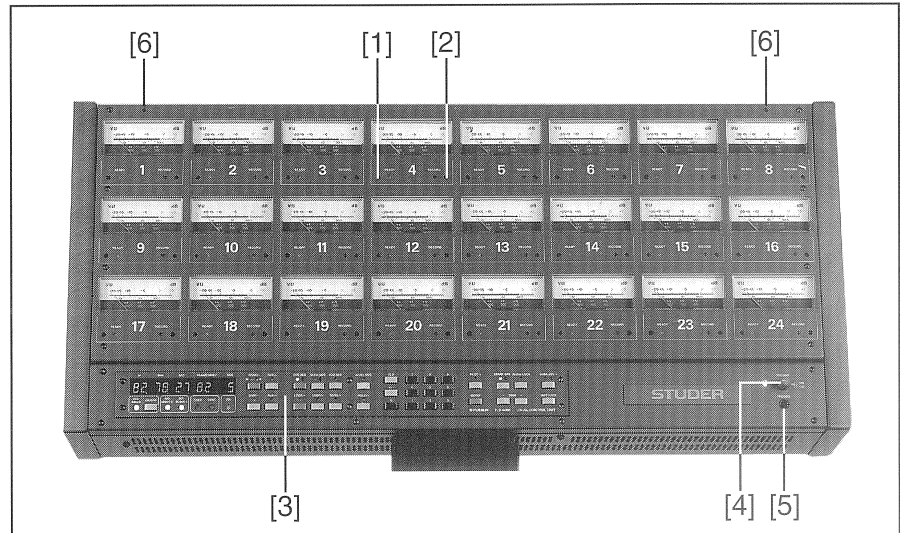

Fig. 1.5.2-1 VU-meter

### Assigning the monitor speaker to an audio channel

- [1] Calibration potentiometer for VU-meter.
- [2] Calibration potentiometer for peak LEDs +6, +9, +12 dB.
- [3] LCU of the TLS 4000 (option).
- [4] Volume control with ON/OFF switch. The desired monitoring channel can be assigned as follows:
  - Unfasten the two hexagon-socket-head screws [6], turn up the VU-panel, see illustration below.
  - Plug the connector [7] into the desired VU-meter row (groups of four) and with the jumper [8] select the desired channel within the channel row. The first jumper position corresponds in each case with the in numerical order lowest channel of the group fourth, e.g. 1,5,9,13 etc.
- [5] ■ Close the VU-panel and lock it with the hexagon-socket-head screws [6]. Headphones socket.

### Assigning the monitor speaker to an audio channel

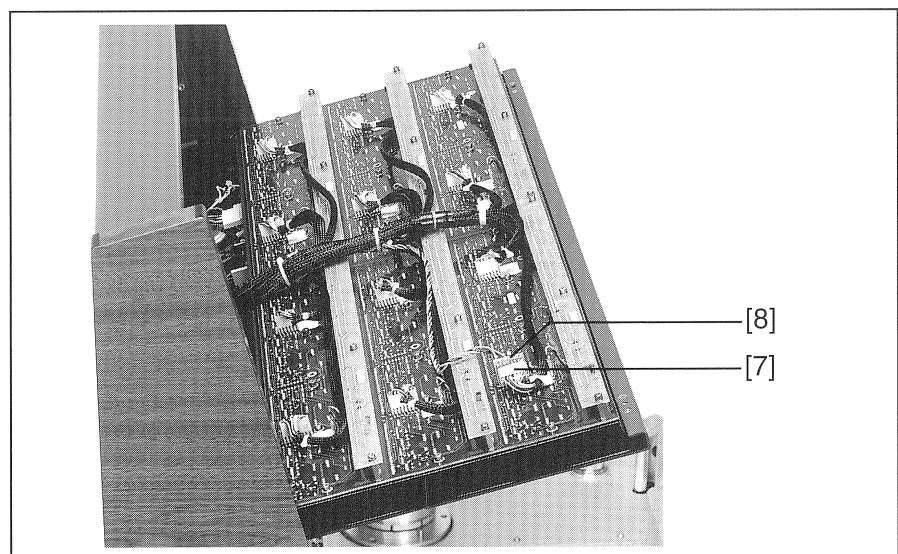

Fig. 1.5.2-2 Assigning the monitor speaker to an audio channel

## 1.6 Operation

---

### 1.6.1 Feedback lamps

---

During the power-on sequence, i.e. while the processor is being initialized, certain keys and indicator lamps such as the READY and REC lamp may possibly light up. During this time the record function is electronically inhibited. After the power-on sequence the following lamps or feedback LEDs light up and indicate the current operating state of the tape recorder:

- **STOP:** The STOP function is active. If this key flashes this means that the two tape tension sensors are in their home position.
- **Tape speed:** e.g. 15 ips.
- **CCIR or NAB:** Indication of the selected equalization standard.
- **Tape A or Tape B:** Selected tape type.

On the LC display the following (equipment specific) information is displayed consecutively for a few seconds (this information can be recalled at any time by pressing the LAST key), refer also section 1.7:

- **Software status:** Release date of the machine software (calendar week / year).
- If the SMPTE/EBU interface is used: specifies whether the SMPTE EBU command protocol is output in RS422 or RS 232 format.
- After a software change or the like, a **warning** is displayed that all key functions of the machine have been assigned to the default functions in accordance with the original lettering and that the standard audio or tape deck data have been read in.
- If the power-on self-test detects a system error, it is output on the LC display; see Section 1.9, otherwise the message "No errors detected" is displayed".
- **Line level** (selected operating and peak recording level) and on units with time code, also the **OFFSET** and the **time code** standard (frames/sec) are displayed.

Additional feedback lamps on the audio remote control:

- On the track selector: **SAFE**
- On the output selector the signal available on the output is indicated (INP, SYNC or REP).

#### Operating voltage monitoring:

On the right-hand side below to upper front cover of the electronics rack, six green LEDs indicate that the supply voltages are available: (+5.6 V, +24 V, +15 V, -15 V, +26 V, -26 V). The three primary fuses are also checked (see Fig. 1.4.1). If they are in order, one LED each (F1, F2, F3) is light.



## 1.6.2 Threading the tape

Thread the tape according to the diagram below. Place the tape leader on the empty reel and secure it by giving the reel a few turns. The pinch roller assembly engages as soon as the tape is tensioned. The STOP key flashes. When a tape command key is pressed, the spooling motors are activated and the tape tension monitoring circuit is enabled.

The tape timer can now be reset to zero by pressing the RESET key. Close the head shield, if necessary.

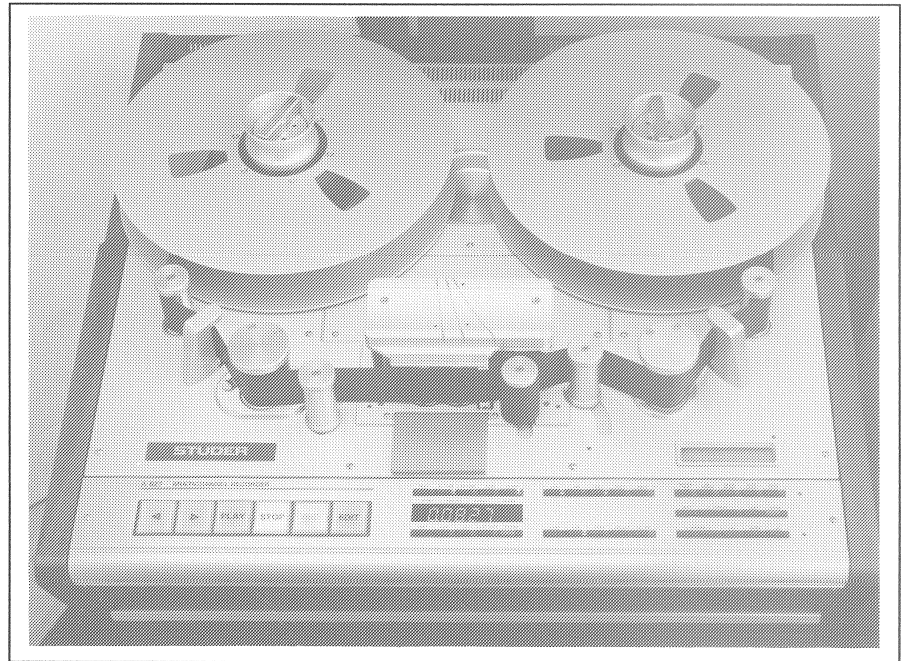

Fig. 1.6.2

**Note:** Close the hinged head shield before threading the head.

## 1.6.3 Tape speeds

7.5 ips / 15 ips / 30 ips

Up to three tape speeds are available. To change the tape speed simply press the desired key; the corresponding feedback lamp lights up. If the speed is changed while a recording is in progress, STOP will be automatically activated.

## 1.6.4 Play

The PLAY key or a fader start device can be used for starting the tape recorder in play mode. The PLAY lamp lights up.

If PLAY is pressed while a recording is in progress, the machine switches automatically to PLAY mode. If PLAY is pressed in spooling mode, the machine decelerates the tape and the PLAY function is preselected. The PLAY key flashes until the play command is executed. From play mode the tape deck can be switched automatically to spooling mode or a locator function.

## 1.6.5 Reverse play

---

The tape deck can be switched to REVERSE PLAY by simultaneously pressing SHIFT and PLAY. The reverse play function can be assigned to a key with F305.

## 1.6.6 Varispeed

---

### Display modes

With the built-in varispeed control the tape speed can be varied by up to  $\pm 7.5$  semitones relative to the selected nominal tape speed.

The variable tape speed can be preselected with SET VARISP [30] and the UP/DOWN keys [44/45]. This preselection does not affect the current nominal play speed.

Depending on the programming (F241-F244) the tape speed is shown on the service display either as:

- Deviation in semitones
- Deviation in percent of the nominal tape speed
- Actual tape speed in ips.

To change over from the nominal tape speed to the varispeed it is necessary to press VARISPEED [29]; the VARISPEED LED flashes.

When the functions SET VARISPEED and VARISPEED are activated simultaneously, the speed can be varied directly by means of the UP/DOWN keys. The result can be immediately heard during playback.

- Note:**
- The drop-in and drop-out time offset of the erase and record head are designed for the nominal tape speed. For this reason an offset will occur when recordings are made in varispeed mode.
  - The real time indication of the tape timer is incorrect in varispeed mode.

## 1.6.7 Record

---

When REC and PLAY are pressed simultaneously, the tape recorder switches to record and the PLAY and REC keys light up.

- Note:** At least 1 channel must be switched to READY mode.

When PLAY and REC are pressed in spooling mode, the machine decelerates the tape. The record function is preselected, the REC and PLAY keys flash.

The record operation is activated as soon as the tape has attained the nominal play speed, and both keys change to continuous light. From record mode it is possible to switch directly to spooling mode or to activate a locator function.

### MASTER SAFE key

The MASTER SAFE function is a higher ranking record inhibition. As long as MASTER SAFE is active, the READY command is ignored and the machine cannot be prepared for a recording.

**Drop in**

Click-free changeover from play or sync play to record mode is feasible. Two modes can be programmed: in play mode, PLAY and REC must be pressed simultaneously (F307: RECORD A), or the function is activated by pressing only the REC key (F308: RECORD B). Depending on the programming the erase and record head are activated simultaneously (DELAY INHIBIT key selected), or the record head is enabled with a tape speed dependent delay in such a way that both heads are activated at exactly the same tape address (DELAY INHIBIT key not selected).

**Drop out**

Click-free changeover from record to play or sync play is possible. Depending on the programming, the erase and record head are either switched off simultaneously (DELAY INHIBIT key selected) or the record head is disabled with a tape speed dependent delay in such a way that both heads are switched off at exactly the same tape address (DELAY INHIBIT key not selected).

### 1.6.8 Spooling

---

**►/◄**

The ► key activates the spooling in the forward direction, the ◄ key in the rewind direction. The spooling speed can be modified in the "alignment deck" menu branch between 0.1 m/s and 15 m/s in steps of 0.1 m/s. The corresponding status indicator lamp lights up.

The spooling functions can be cancelled with the commands STOP, PLAY, REC+PLAY, EDIT or LOC.

The tape deck functions can be selected directly, i.e. it is not necessary to press STOP first.

From spooling mode it is possible to switch directly to play or record. In this case the preselected key flashes until the corresponding tape speed is attained.

**Library wind**

Because the edges of roughly wound pancakes can become damaged, the spooling speed can be reduced for producing library pancakes. The library wind speed can be modified in the "alignment deck" menu branch in steps of 0.1 m/s. This function is activated by simultaneously pressing SHIFT and one of the spooling keys. The library wind function can be assigned to a key with F303. When this function is active, the machine spools in either direction with the preselected library wind speed.

### 1.6.9 Stop

---

The STOP key has the highest priority and interrupts all other operating modes such as play, record, spooling and locator.

The tape tension control is always active. For one-handed cueing the tape can be positioned by turning either spindle, but the brakes are still active.

A command that is entered during the deceleration phase will be executed as soon as the tape speed conforms to the selected function.

**1.6.10 Editing, tape splicing**

---

- Searching a tape address**
- For cutting out specific tape segments, the approximate tape location can be searched with the PLAY, ◀/▶ or locator function (or with the aid of the SHUTTLE wheel).
  - Press the EDIT key and position the tape at the exact edit position by carefully turning either spindle (manual editing).
- Marking the tape, cutting in the splicing block**
- With a grease pen or a soft pencil mark the tape position located under the reproduce head on the back of the oxide coating. Insert the marked tape position into the splicing rail (on the headblock) in such a way that the tape can be cut with a razor blade in the corresponding slot.
- Splicing the tape**
- Place the tape ends to be spliced with the oxide coating facing downward into the splicing block. Butt the ends together (without overlap!) and join them with adhesive tape.

**1.6.11 Dump edit mode (tape dump)**

---

In dump edit mode the right-hand spooling motor is switched off. Unwanted tape segments can be played into the waste basket.

The following modes can be selected with the functions F327–F330:

<b>Dump edit modes F327–330:</b>	<b>A</b>	<b>B</b>	<b>C</b>	<b>D</b>
Tape timer active	■		■	
Tape timer switched off		■		■
Direct selection key TAPE DUMP (Cancel with STOP or TAPE DUMP)	■	■		
Preselection key TAPE DUMP Activate with PLAY (Cancel with STOP or TAPE DUMP)			■	■

### Winding up a loose tape segment

If too much tape has been unintentionally dumped into the waste basket, it is not necessary to rewind it manually. Thread the tape as shown in the diagram. Tension the tape with two fingers (preferably with gloved hands) and continuously hold down the REWIND key. The left-hand spooling motor rotates and slowly winds up the loose tape. The motor stops as soon as you release the ◀ key.

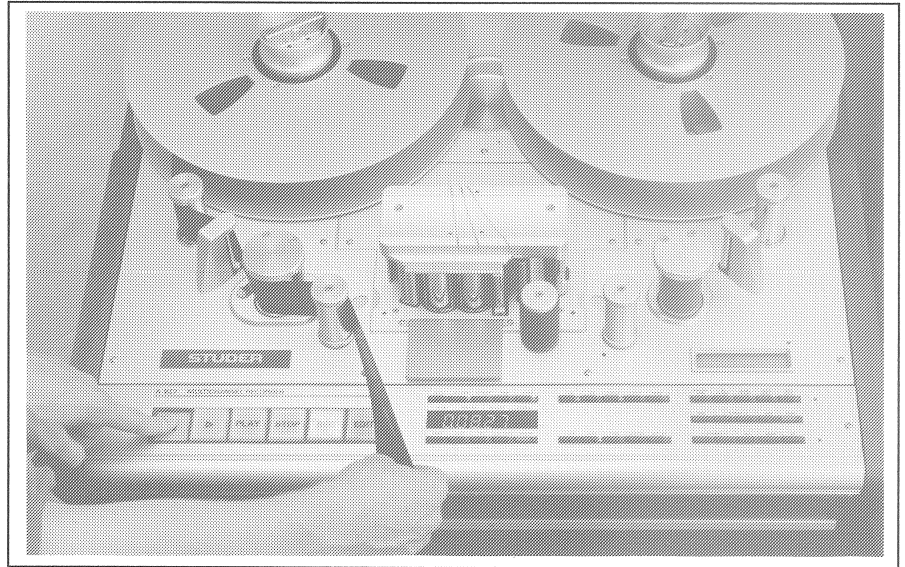

Fig. 1.6.11-1 Winding up a loose tape segment

The motor torque is limited and controlled in such a way that the tape can be decelerated by hand without difficulty. When you release the tape, the motor rotates very slowly. The speed increases as soon as you tension the tape manually.

The type can be wound up analogously on the right-hand spindle by pressing the ▶ key.

### Playing a cut tape segment

After prolonged editing work it is possible that you have cut out a large number of tape segments and you don't know which is the start or the end of the segment. With the A827 MCH tape recorder you can play such tape segments without first splicing them together and winding them on a reel.

**Procedure:** Press the EDIT key. The tape lift pin and the pinch roller assembly engage. The EDIT lamp flashes. Insert a tape segment as shown in the diagram.

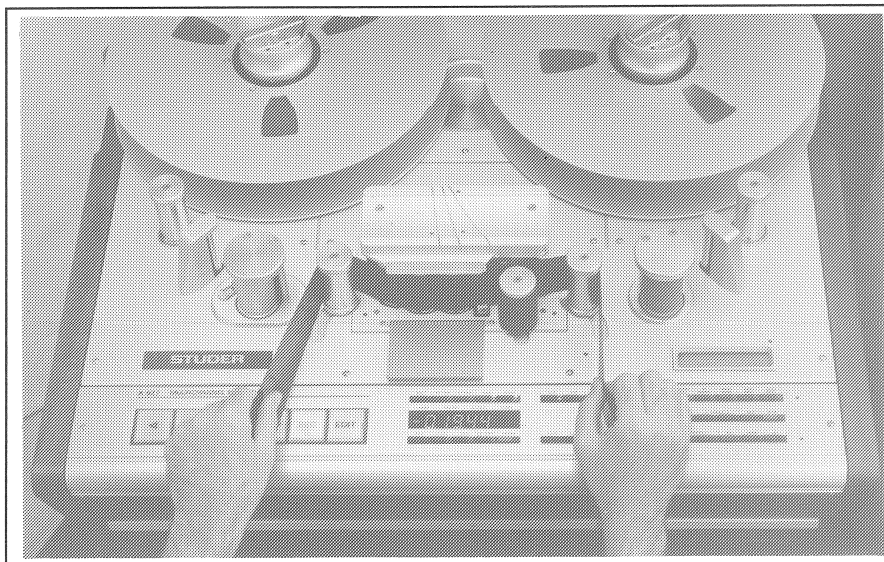

**Fig. 1.6.11-2** Playing a cut tape segment

With your left hand lightly tension the tape on the left-hand side of the headblock and with your right hand press the Tape dump key. The tape segment is pulled across the reproduce head and can be monitored. Lightly tensioning the tape with your left hand will improve the head contact of the tape (better audio quality).

The PLAY function can be interrupted by pressing the EDIT key. When the STOP key is pressed the pinch roller assembly disengages.

## 1.6.12 Locator

---

<b>ZERO LOC</b>	The locator supports the following modes: Zero locator. When this key is pressed the tape is spooled forward or backward to the tape address 0.00.00. This applies also to the LAP time base.
<b>LOC START</b>	When this key is pressed, the tape spools forward or backward to the address at which the last PLAY or REC command was entered (when the tape was standing still). Depending on the programming (F319-F321), the machine then switches to STOP, play or record.
<b>LOC1</b>	A tape address can be stored and automatically searched in spooling mode by pressing the LOC1 key.
<b>Programming</b>	Search the desired tape address. Press the SHIFT key. The feedback lamp lights up. Press the LOC1 key, the SHIFT feedback lamp switches off.
<b>Displaying a stored LOC address</b>	While the tape position is being searched press the LOC key again; or in STOP mode press STOP together with the corresponding LOC key.
<b>Preselection of PLAY or REC</b>	When PLAY is pressed once during a locate function (ZERO LOC, LOC START, LOC1...5) or when PLAY is pressed together with REC, the tape recorder switches automatically to record or play when the corresponding tape address is reached.

For LOC start the play or record preselection can be programmed directly:

- F319:** LOC START PLAY, only REC preselection possible → play is selected automatically.
- F320:** LOC START STOP; preselection REC/PLAY possible.
- F321:** LOC START REC; REC preselection deselectable with play.

All locate addresses remain stored even when the tape recorder is switched off.

**Important:** The locator addresses are not converted when the tape counter is reset to zero, switched to LAP timer, or loaded with a different value with the SET TIMER function.

### 1.6.13 Tape timer

The electronic tape timer always indicates the real time in hours, minutes and seconds relative to the selected nominal tape speed.

The tape timer display has a range of -9 h 59 min 59 s to 23 h 59 min 59 s. Values outside this range are indicated with "u" (underflow, negative value too small) or "o" (overflow, positive value too large) in the tens position of the hours, e.g. 04.00.00 or u3.03.35.

The tape timer can be set to 0.00.00 with the RESET key.

When the end of the tape is reached the tape timer stops automatically.

In TAPE DUMP mode the tape timer continues to run or stops, depending on the programmed TAPE DUMP version.

Basic programming: TAPE DUMP A; the tape timer is updated with the tachometer information supplied by the capstan motor.

### 1.6.14 LAP tape timer

With the LAP key (F334) the tape timer display can be switched to a second (auxiliary) tape timer with a user-selectable reference. When the LAP timer is active this will be indicated with the letter "L" in the first display position.

The LAP timer can be set to zero with the RESET key in any tape position. In this way the playing time of a selection can be determined exactly without the need for computing the difference between the starting and ending time. When the LAP key is pressed again, the display is switched back to the main timer and the "L" in the first display position disappears.

The locator addresses are not affected by the change in the tape timer display mode.



Fig. 1.6.14-1 LAP timer display

### 1.6.15 Parallel remote control

The following functions can be operated with a parallel remote control:

- PLAY
- STOP
- REC
- ◀
- ▶
- RESET TIMER
- ZERO LOC
- LOC START
- BACKSPACE (rewind for as long as this key is pressed, followed by PLAY)
- LIFTER (defeats the tape lifting in spooling mode)
- FADER (FADER START ready).

With F345/346 two different operating modes can be programmed:

Function-table for TD-REM-Key

Programming	Rem.A only Remote Control		Rem.B Remote Control + Local		None active <sup>1</sup>
	Selected <sup>2</sup>	Deselected <sup>3</sup>	Selected <sup>2</sup>	Deselected <sup>3</sup>	
Local keyboard active	-	■	■	■	■
Remote control parallel, serial and RS232 <sup>4</sup> inactive	■	-	■	-	■

- Note:**
- TD REM can only be selected in stop mode.
  - TD REM also switches the RS 232 interface on and off!

<sup>1</sup>Neither Remote A nor Remote B are active, that means F345 and F346 are "NO" set.

<sup>2</sup>Yellow LED lit.

<sup>3</sup>Yellow LED doesn't lit.

<sup>4</sup>In conjunction with the TLS4000 the remote control must be selected!



## 1.6.16 Time code channel

- With the aid of the menu tree, any channel can be defined as the time code channel.
- To access the programming level, press the enable button [46] with a thin object, see foldout page 1/4.
- Starting with the standard indication "FLUX LEVEL: NORMAL" on the LC display press the following keys in the specified order:

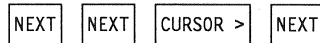

- The display shows:

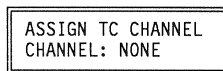

- Select the desired channel with the key CHANNEL </> and press STORE.
- To quick the menu tree press the LAST key three times.

**Note:**

- The time code is recorded on tape via the audio amplifier.
- Changes in the parameters of the time code channel (in the menu tree: Alignment TC) have no influence on the audio data. Conversely, the time code parameters are not influenced when the audio parameters of the corresponding channel are modified.

**Time code recording and reproduction:**

You can preselect the record function by pressing the READY key of the time code channel on the audio remote control. To cancel the function press READY again.

To prevent unintentional erasure of the time code channel, the READY ALL function does not act on the selected time code channel.

**Displaying the time code level:**

INPUT mode: On the VU-meter the current level at the TC input is displayed.  
 SYNC mode: On the VU-meter the current time code level from tape (record head) is displayed.  
 REPRO mode: On the VU-meter the current time code level from tape (record head) is displayed.

## 1.7 Menu tree, soft keys

---

The A827 MCH features a total of over 100 functions and operating modes. Less frequently used functions and operating modes can be selected and modified in the menu tree.

The control keys (except those in the two bottom rows in the right-hand key pad) can be assigned to any function. In this way operator functions can be arranged individually.

- Note:**
- To make it easier to follow the explanations given below, page 1/41 should be folded out for reference purposes.
  - Words that are written in capital letters such as NEXT, UP, DOWN refer to control keys.
  - Programming is only feasible when the tape recorder is in STOP or TAPE OUT condition.

### 1.7.1 Entering the menu tree

---

**NEXT, CURSOR </>, LAST** With these four keys you can move through the menu tree to the desired setup windows.

When the machine functions correctly the following **standard information** is displayed:

```
FLUX LEVEL: NORMAL
HX: OFF    TC: NONE
```

It provides information on:

- Selected tape flux (adjustable with F001: normal, +2 or +6 dB tape flux).
- Status of Dolby HX PRO (adjustable with F047)
- Status or assignment of the time code track (adjustable with "Assign TC channel" in the audio alignment branch).

When the LAST key is pressed, the same information appears that is also displayed for a few seconds after the machine has been powered on.

```
A827MCH MULTICH VERS:
MASTER: 05/91
```

**Important:**

Release date of the software of the MASTER MPU, 05/91 = calendar week/year.

This software date should be mentioned in any contacts with your Studer dealer.

```
SERIAL IF SETTING
RS 422 SMPTE/EBU
```

This information appears only if the option SMPTE/EBU interface 1.820.751.xx is configured and set to the RS422 format.

```
SERIAL IF SETTING
RS 232
```

This information appears only if the option SMPTE/EBU interface 1.820.751.xx is configured and set to the RS232 format.

WARN: DEFAULT  
-----

Loss of data in the data memory, the data must be reloaded. Three different warnings can appear:

- DEFAULT KEYS LOADED: The keys correspond to the factory programming.
- DEFAULT PARAMETERS LOADED: The audio alignments and tape tension settings correspond to the factory programming.
- DEFAULT KEYS & PARAMETERS LOADED: The keys, audio alignments and tape tension settings correspond to the factory programming.

ERROR MESSAGE  
no errors detected

A self-test is performed whenever the A827 MCH is powered on. If no fault is detected, the above information is displayed, otherwise a plain-text error message is output (see 1.9.1).

## 1.7.2 The tree main branches

The menu tree can basically be subdivided into three main branches:

- Display branch for the SET TIMER, SET ADDRESS and VARISPEED keys.
- Setup branch for audio and tape deck parameters
- Keys and function programming branch

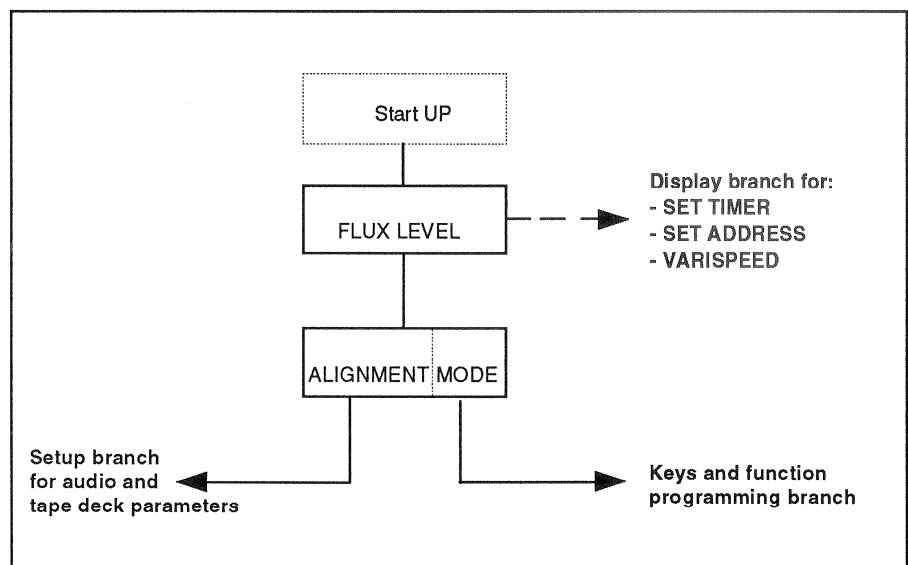

**Display branch for the SET TIMER, SET ADDRESS and VARISPEED keys:**

When the SET TIMER, SET ADDRESS and VARISPEED keys are pressed, the current settings are displayed which can be adjusted with the CURSOR UP and DOWN keys.

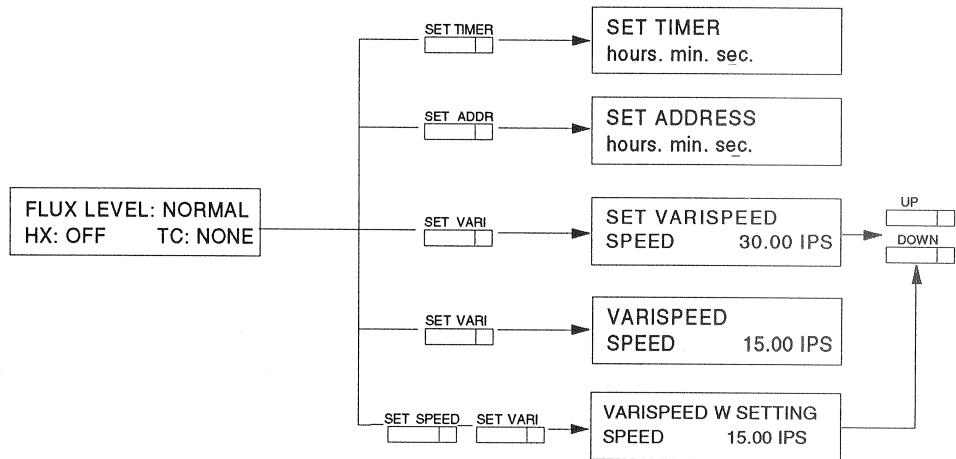

**Example: Changing the tape timer setting**

Display shows:

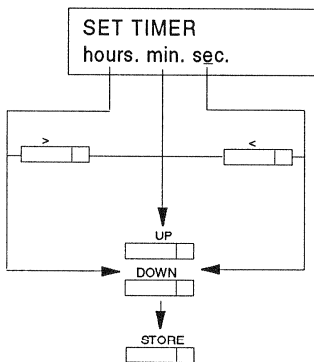

Operating steps:

- Switch machine to STOP
- Press the following key: SET TIMER
- You can enter the seconds by pressing the UP or DOWN key.
- With the CURSOR keys </> select the minutes or hours position and enter the desired value by pressing the UP or DOWN key.
- Save the entered value by pressing the STORE key.

**Example: Programming a locator address on a LOC1...5 key**

Display shows:

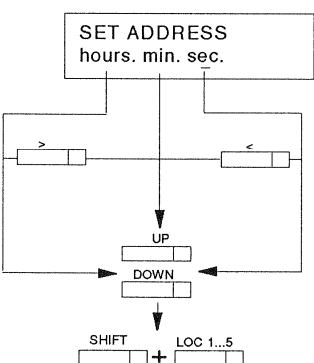

Operating steps:

- Switch machine to STOP
- Press the following key: SET ADDRESS
- You can enter the seconds by pressing the UP or DOWN key.
- With the CURSOR keys </> select the minutes or hours position and enter the desired value by pressing the UP or DOWN key.
- Save the entered value by simultaneously pressing the SHIFT key and one of the LOC1...5 keys.

## Setup branch

Starting from the standard information shown in Section 1.7.1 you can access the setup branch by pressing:

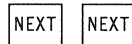

The selection window for the setup branches:

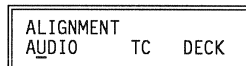

- Audio
- Time code (TC)
- Tape deck (DECK)

**CURSOR </>, LAST, NEXT:**

With the CURSOR key move the dash segment below the desired branch. With the NEXT key you can browse through the individual setup functions within this branch.

To browse in the reverse direction press the LAST key.

**UP, DOWN, STORE:**

- These values can be entered with the UP and DOWN keys.
- To save the entered values press the STORE key.

**CHANNEL </>, ALL:**

Channel selection key for the audio setup branch. For the channels that have been selected the READY and REC LED lamp flashes/glows on the VU panel.

### Example: Setting the reel diameter to 12.5"

Display shows:

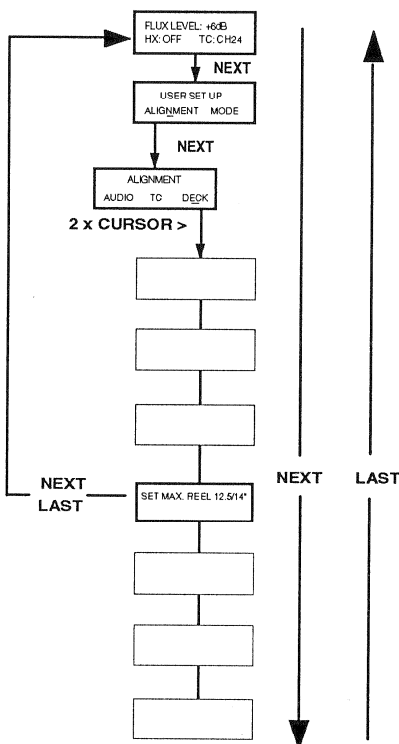

Operating steps:

- To access the programming level press the enable key [46] with a thin object, see foldout page 1/4.

- Switch the machine to STOP.

- Press the following keys:

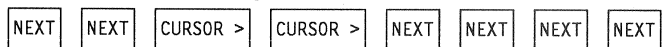

- With the UP or DOWN key enter the desired diameter of 12.5".

- Press STORE to save the entered value.

**Note:**

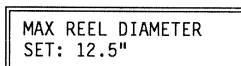

Each time the STORE key is pressed the next possible setting is stored.

- Advance to the next parameter or press LAST to return to the start of the menu tree.

Beginning with the software release 10/92 you can exit from the menu branch directly by pressing NEXT and LAST.

## Key and function programming branch

---

Starting from the standard information shown in Fig. 1.7.1 you can access the key and function programming branch by pressing:

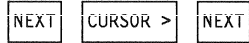

In a selection window the three keys and function programming branches are displayed:



- Audio
- Tape deck (DECK)
- Time code (TC)

### CURSOR </>

With the two CURSOR keys move the dash segment under the desired branch.

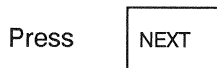

The following window appears:

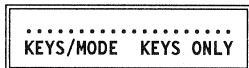

With the two CURSOR keys move the dash segment below the desired branch. By pressing the NEXT key you can now access the key or function programming branch. You can browse through the individual key or function programming windows by pressing UP. With the DOWN key you can page backward.

### KEYS/MODE

Key and function programming, for an example see page E1/24

All functions under the KEYS/MODE branches can be selected/deselected directly in the opened window or they can be program assigned to a key. I.e. the menu window is terminated after the key has been programmed and the function can be selected/deselected by pressing the programmed key.

#### Example: F021 master safe

##### Direct programming:

If F021 master safe is programmed directly, this represents a continuous state, i.e. for deselecting master safe this window must again be selected in the menu.

##### Key programming:

F021 master safe can be assigned to any tape deck key and be selected or deselected at any time by pressing the programmed key.

### KEYS ONLY

Key programming. For an example see page E1/25

All functions under the KEYS ONLY branches must be program assigned to a key. After the program the menu window is terminated and the function can be selected/deselected by pressing the programmed key.

To return to the start of the corresponding setup branch press the LAST key:

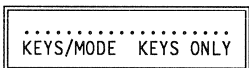

The two possibilities in the KEYS/MODE windows:

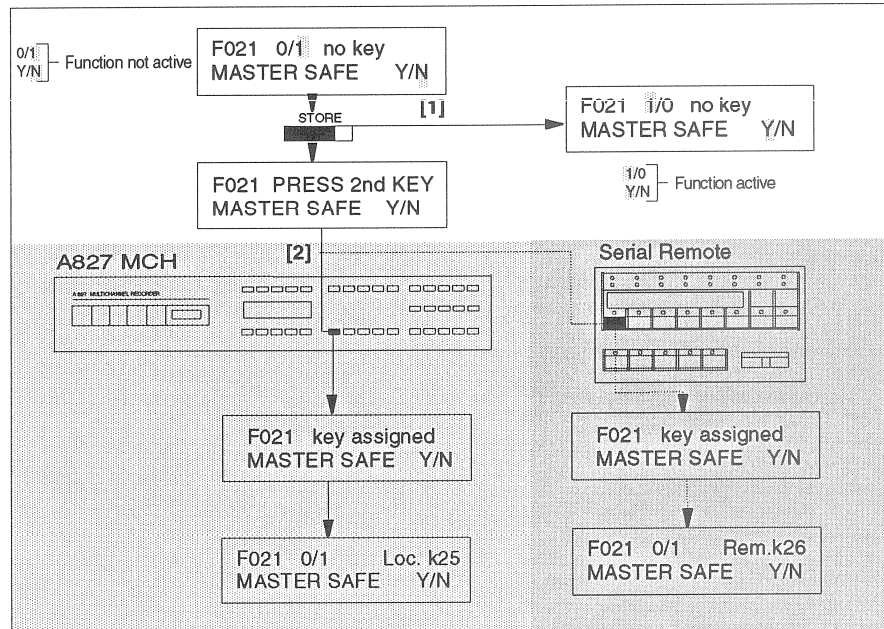

- [1] Release the STORE key
- [2] Press the STORE key plus the key on which the function is to be programmed

- Activate the function without assigning it to a key
- Assign the function to a key on the A827
- Assign the function to a key on the serial remote control

Key numbering

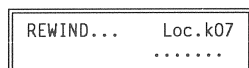

In the key mode windows the key number, e.g. loc.07, is displayed on the right-hand side of the first line.

- Loc. refers to the key number of the local keyboard on machine
- Rem. refers to the key number of the remote control

**Example:** Assuming the library wind functions has been reprogrammed to the key REM IF. When the library wind window is selected in the menu tree, loc.31 is displayed on the right-hand side of the first line.

Checking the function assignment

When you are located in the key and function programming path, the function assigned to a key can be read off the LC display by pressing the corresponding key, i.e. the current key labelling can be checked against the actual function assignment.

Key numbering of the A827 MCH (Loc.)

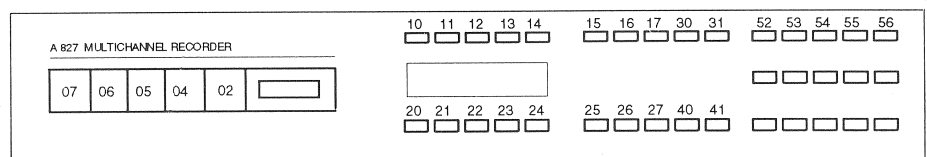

Key numbering of the serial remote control (Rem.)

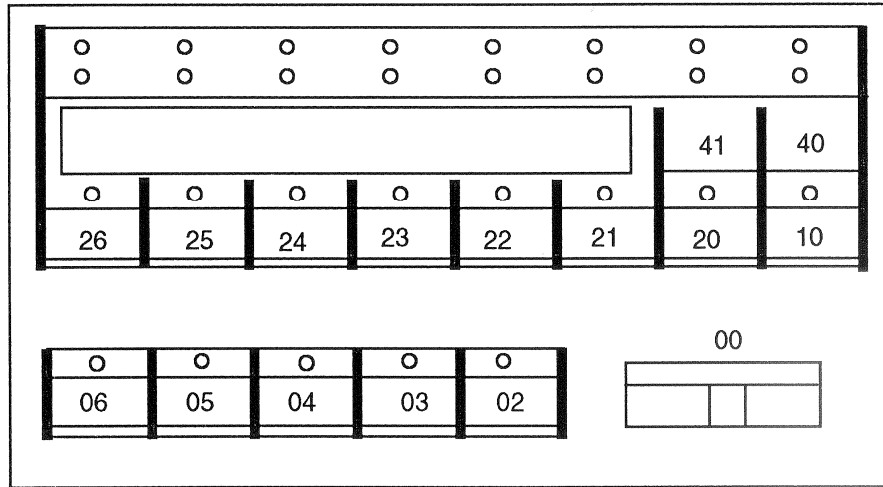

Example 1, KEYS/MODE: Setting AUTO INPUT mode B (function 052)

Display shows:

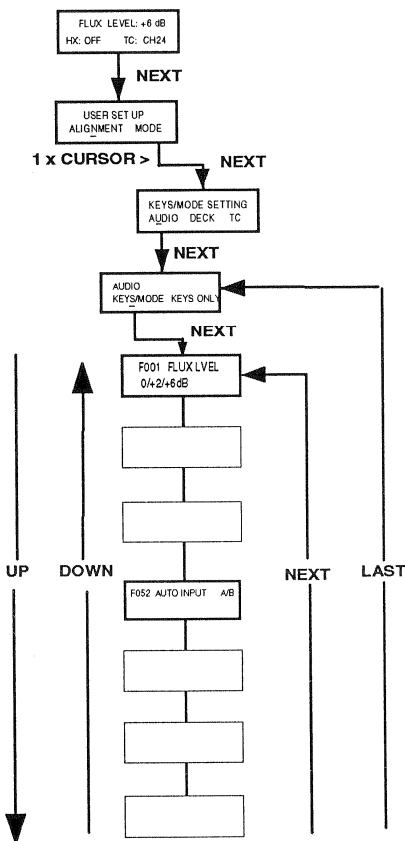

Operating steps:

- To access the programming level, press the enable key [46] with a thin object, see foldout page 1/4.
- Switch the machine to STOP
- Press the following keys:



The following information is displayed:

F 001 Flux Level  
0/+2/+6 dB

- Page to F052 by pressing the UP key
- Press STORE

Note:

F 052 0/1 NO KEY  
AUTO INPUT A/B

0/1 means that B is active  
1/0 means that A is active  
You can toggle between A and B by pressing the STORE key.

- With the UP/DOWN keys page to the next setting or press LAST to return to the start of the menu tree. Beginning with the software edition 10/92 you can exit from the menu branch directly by simultaneously pressing NEXT and LAST.
- Press the enable [46] key again to bar the programming access.



**Example 2, KEY ONLY: Reprogramming of the RESET key (loc. 10) to REVERSE PLAY (F305)**  
**Display shows:**

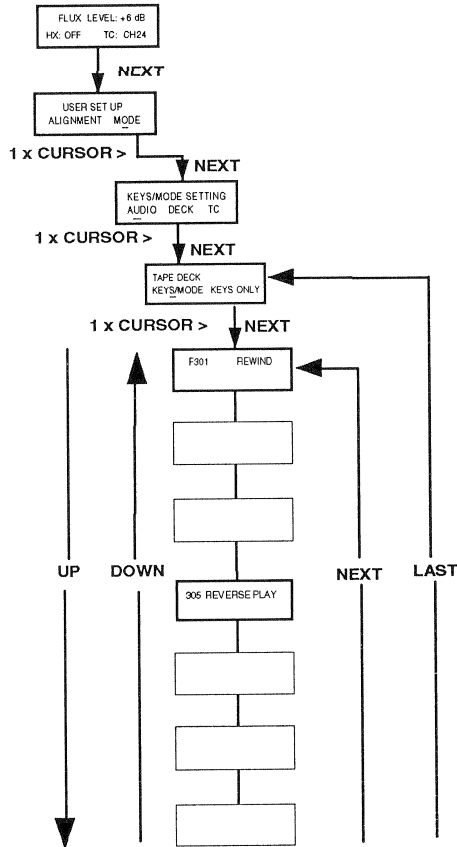

**Operating steps:**

- To access the programming level, press the enable key [46] with a thin object, see foldout page 1/4.

- Switch the machine to STOP

- Press the following keys:

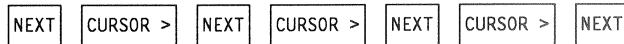

The following information is displayed:

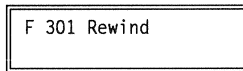

- Page to F305 reverse play by pressing the UP key
- Press STORE plus RESET TIMER, Loc. 10 (see key numbering E1/24)
- With the NEXT or UP/DOWN keys page to the next programming or press LAST to return to the start of the menu tree. Beginning with the software edition of spring 1992 you can exit from the menu branch directly by simultaneously pressing NEXT and LAST.
- Change the key label
- Press the enable [46] key again to bar the programming access.

## 1.7.3 Description of the menu windows in the audio setup branch

### General information:

- The audio setup branch is only used in conjunction with the audio alignment of the A827 MCH, see Section 4.
- The settings always refer to the tape speed shown in the corresponding menu window.  
Settings for other tape speeds are possible but the desired tape speed must first be selected.
- All audio settings for a second tape type can be established by pressing the STOP and TAPE B key.
- CH 0...24 can be selected with the CHANNEL </> keys.

### Display shows:

```
CHANNEL MODE
INDIV  REP  SYNC  INP
```

### Functional description:

If the A827 MCH is operated without the audio remote control, the channel status can be selected via this window.

INDIV = Individual; operation via the audio remote control  
 REP = Repr; all channels are switched to reproduce mode  
 SYNC = Synchronous; all channels are switched to SYNC reproduction  
 INP = Input; the input signal is directly through-connected to all channels.

```
REP LVL 7.50 NAB A
CH 23  --
```

Selection of the LEVEL setting REPRODUCE or SYNC REPRODUCE mode for tape type A, equalization NAB, at 7.50 ips, channel 23.

```
REP TRB 15.0 CCIR A
CH 23  --
```

Selection of the TREBLE setting in REPRODUCE or SYNC REPRODUCE mode for tape type A, equalization CCIR, at 15.0 ips, channel 23.

```
REP BASS 7.50 NAB A
CH 23  --
```

Selection of the BASS setting in REPRODUCE or SYNC REPRODUCE mode for tape type A, equalization NAB, at 7.50 ips, channel 23.

```
CHNL READY SELECTION
INDIV  ALL READY
```

If the A827 MCH is operated without audio remote control, the record mode can be enabled via this window.

INDIV = Individual; recording on the channels is enabled from the remote control  
 ALL READY = All channels are enabled for recording.

```
REC LVL 7.50 NAB A
CH 23  --
```

Selection of the RECORD LEVEL setting for tape type A, equalization NAB, at 7.5 ips channel 23.

```
BIAS CAL 15.0 NAB A+B
CH 23  --
```

Selection for individually **setting the bias** for each channel at 15 ips, equalization NAB, for tape type A+B common.

```
M-BIAS 15.0 NAB A
ALL
```

Selection for **simultaneously setting the bias of all channels** at 7.5 ips and 30 ips, equalization NAB, tape type A.

```
REC LVL 7.50 NAB A
CH 23  --
```

Selection for setting the RECORD LEVEL for tape type A at 7.50 ips, equalization NAB, channel 23.

```
REC TRB 15.0 CCIR A
CH 23  --
```

Selection for setting the TREBLE in RECORD mode for tape type A, equalization CCIR at 15.0 ips, channel 23.

```
REP BASS 7.50 NAB A
CH 23  --
```

Selection of the BASS fine adjustment in PLAY mode for tape type A, equalization NAB at 7.50 ips, channel 23.

```
REC LVL 7.50 NAB A
CH 23  --
```

Selection of the RECORD level fine adjustment for tape type A, equalization NAB at 7.50 ips, channel 23.

### 1.7.4 Description of the menu windows in the time code setup branch

#### General information:

- The TC settings do not cancel the audio settings of the selected channel, i.e. the audio data of the corresponding channel are reactivated as soon as the TC channel is deselected or assigned to a different channel. Conversely, the audio settings do not influence the TC settings when the TC channel is used for audio recording.
- All audio settings for a second tape type can be established by pressing the STOP and TAPE B key.

#### Display shows:

```
ASSIGN TC CHANNEL
CHANNEL:--
```

Any channel can be selected for time code recording by pressing the CHNL </> keys. Storing with the STORE key.

```
CHANNEL MODE
INDIV REP SYNC INP
```

If the A827 MCH is operated without audio remote control, the time code channel status can be selected via this window.

INDIV = Individual; operation via the audio remote control

REP = Repro; the time code channel is switched to reproduce mode

SYNC = Synchronous; the time code channel is switched to sync reproduction.

INP = Input; the input channel is directly through-connected to the time code channel.

```
REP LVL 15 IPS CCIR A
TC CHANNEL:--
```

Selection of the REPRODUCE or SYNC REPRODUCE level setting of the time code

```
REC LVL 15 IPS CCIR A
TC CHANNEL:--
```

Selection of the RECORD level setting of the time code.

## 1.7.5 Description of the menu windows in the tape deck setup branch

### Display shows:

```
SET LIB WIND SPEED A
0.50 m/s
```

```
SET MAX WIND SPEED A
15.0 M/S
```

```
SET ROLLBACK TIME
15 SEC
```

```
MAX REEL DIAMETER
SET: 14" (356mm)
```

```
T TENS PLAY 2" A
LEFT -- RIGHT--
```

```
T TENS WIND 2" A
VALUE: 60
```

```
T TENS EDIT 2" A
VALUE: 89
```

```
T T REV PLAY 2" A
LEFT_ RIGHT:_
```

```
SET ES BUS ADDRESS
MSB 82 LSB 80
```

```
BIN RS232/422 FORMAT
SET: 8, ev par, 1 sb
```

```
ASCII RS 232 BD RATE
9600Bd 1200Bd 300Bd
```

```
ASCII RS 232 MODE
ECHO NO ECHO
```

### Functional description:

Set the correct library wind speed for tape type A or B. To obtain a compact, smooth pancake for the archive, the spooling speed can be adjusted to the corresponding tape quality. Adjustment range: 0.1 to 15.0 m/s<sup>5</sup>.

Set the spooling speed for tape type A or B. For producing self-supporting pancakes from tapes with a satin finish on the back side, the spooling tape can be correspondingly reduced. Adjustment range: 0.1 m/s to 15 m/s<sup>6</sup>.

Determine the time by which the tape recorder rolls back when the programmable rollback functions are activated (F322-F324).  
Example: LOC point 15 s before the current tape timer address.

Input the most frequently used pancake diameter. Optimizes the dynamic behavior of the tape deck to the pancake size.

Select the PLAY tape tension for tape type A or B, tape width 2". Concerning the tape tension adjustment refer to Section 3.

Select the tape tension in spooling mode for tape type A or B, tape width 2". Concerning the tape tension adjustment refer to Section 3.

Select the tape tension in EDIT mode for tape type A or B, tape width 2". Concerning the tape tension adjustment refer to Section 3.

Select the tape tension setting in REVERSE PLAY mode for tape type A or B, tape width 2". Concerning the tape tension setting refer to Section 3.

Set the SMPTE/EBU bus address.  
For addressing the A827 MCH in interconnected system operation with the SMPTE/EBU bus option 1.820.751.XX.

Set the BINARY CODE FORMAT for the option SMPTE/EBU interface 1.820.751.XX.

8 = 8 bit code  
ev par = even parameter  
odd p = odd parameter  
1 sb = 1 stop bit

Set the baud rate for the option RS 232 with ASCII protocol 1.810.751.XX

Set the ECHO or NO ECHO function of the option RS 232 1.810.751.XX with ASCII protocol.

<sup>5</sup>The upper library wind speed is limited through the maximum wind speed setting.

<sup>6</sup>The lower wind speed is limited through the minimum library wind speed setting.

TRIM NOMINAL SPEED SET: +0.000%
------------------------------------

TRIMMING of the NOMINAL SPEED. The nominal tape speed can be corrected in increments of 1/4%, e.g. for adjusting the speed to a second machine or for fine-adjusting the tape speed with a stroboscope. Range  $\pm 0.2$  m/s.

**Warning:** There is no warning message that the stored tape speed will be changed!

## 1.7.6 Description of the menu windows in the audio key and function programming branch

Audio functions that can be program assigned to a key directly in the menu window:

### Display shows:

F001 0/0/1 no key FLUX LEVEL: 0/+2/+6dB
--------------------------------------------

### Functional description:

The flux level specifies the tape flux with which the machine operates. The tape flux level can be increased by 2 or 6 dB by pressing STORE. Example: The nominal tape flux is 250 nWb/m.

- Select +2dB, the tape flux is now 320 nWb/m;
- Select +6dB, the tape flux is now 510 nWb/m.

The selected tape flux appears in the standard picture of the LC display and on the audio remote control as LED acknowledgment.

F021 0/1 Loc.k52 MASTER SAVE Y/N
-------------------------------------

- Y: The higher ranking SAFE function prevents unintentional erasure of tapes.  
N: Function not active.

F022 0/1 Loc.k17 TAPE A Y/N
--------------------------------

- Y: When the TAPE A and the STOP key are pressed simultaneously, the parameters for tape type A are activated.  
N: The parameters for tape type A are not selected.

F023 0/1 Loc.k17 TAPE B Y/N
--------------------------------

- Y: When the TAPE B and the STOP key are pressed simultaneously, the parameters for tape type B are activated.  
N: The parameters for tape type B are not selected.

F024 0/1 Loc.k17 TAPE A/B
------------------------------

To toggle between tape type A and B, simultaneously press the TAPE A/B and the STOP key.

F029 0/1 Loc.k17 CCIR Y/N
------------------------------

- Y: When the CCIR and the STOP key are pressed simultaneously, the CCIR equalization standard is activated.  
N: The CCIR equalization standard is not selected.

F030 0/1 Loc.k17 NAB Y/N
-----------------------------

- Y: When the NAB and the STOP key are pressed simultaneously, the NAB equalization standard is activated.  
N: The NAB equalization standard is not selected.

F032 0/1 Loc.k17 CCIR/NAB
------------------------------

To toggle between CCIR/NAB equalization, simultaneously press the CCIR/NAB and the STOP key.

<sup>7</sup>When the tape recorder is powered on, the previously selected tape type is activated.

<sup>8</sup>When the tape recorder is powered on, the previously selected equalization is activated.

F041 0/1	Loc.k56
AUTO MUTE	ON/OFF

- ON: Automatic muting enabled:
- During spooling (except when there is tape/head contact for cueing)
  - During the capstan acceleration phase
  - In STOP mode
- OFF: Automatic muting disabled.

F044 1/0	Loc.k54
IN/OUT DELAY	Y/N

- Drop-in/drop-out delay.
- Y: Delay compensation between erase and record head is active.  
Rehearse is only feasible when the delay compensation is active.
- N: Delay compensation is not active.

F047 1/0/0/0	no key
HX PRO A/B/C/D	

- Dolby HX PRO can be switched on as a function of the tape speed as follows:
- A: Switched off at all tape speeds
- B: Switched on at 7½ ips, OFF at 15 ips and 30 ips
- C: Switched on at 7½ ips and 15 ips, OFF at 30 ips
- D: Switched on at all tape speeds

F052 1/0	Loc.k13
AUTO INPUT A/B	

- A: All channels in SYNC status switch to INPUT in the following modes:
- STOP
  - REWIND
  - FORWARD
  - LOCK
  - ROLLBACK
- B: Channels in SYNC and READY status switch to INPUT in the following modes:
- STOP
  - REWIND
  - FORWARD
  - LOCK
  - ROLLBACK

F054 1/0	no key
NRS DOLBY/TELCOM	

If a noise reduction system is controlled via the 15-pin D-type connector, this function can be used for adjusting the polarity of the changeover logic to your system.

DOLBY ON: The open collector output is active LOW.

TELCOM ON: The open collector output is active HIGH.

Note: At the same time jumper JS 1 on the NRS IF 1.820.816.00 board must be changed.

Pos. T: Telcom

Pos. D: Dolby

F059 1/0	no key
READY RECORD	Y/N

- Y: Direct punch-in
- If a READY key is pressed while the tape deck operates in record mode, recording is activated immediately.
  - Channels that are in record mode can be deselected from record mode by pressing the READY key.
- N: Record preparation by group
- During a recording all channels that are switched to SAFE can be prepared for recording by pressing the READY key. The preselected channels switch to record when an additional RECORD command is entered (REC+PLAY).
  - Channels that are in record mode can be deselected from record mode by pressing the READY key.

## Note:

- When master SAFE (F021) is selected the tape does not accept the record command.
- In direct punch-in mode, the tape deck accepts the record command even if no channel is switched to READY.

F061	0/1	no key
DROP OUT DELAY		Y/N

## Drop-out delay of

Y: Cancellation the delay compensation between the erase head and the record head during the drop-out.

N: No cancellation of the delay compensation between the erase head and the record head during the drop-out.

F062	1/0	no key
AUTO INPUT		Y/N

Y: Activates the stored AUTO INPUT mode F052.

N: The stored AUTO INPUT mode F052 is not activated.

F071	7.50	no key
COPY REP/SYN PAR A>B		

The reproduce parameters measured for TAPE SORT A such as:

- REPRODUCE LEVEL/SYNC LEVEL
- REPRODUCE TREBLE/SYNC TREBLE
- REPRO BASS/SYNC BASS
- REPRO EQU/SYNC EQU

can be copied by pressing the STORE key on TAPE SORT B.

For copying all parameters for tape type A to type B this procedure must be repeated for all three nominal tape speeds.

- F072 for 15 ips
- F073 for 30 ips

The successful completion of the copying process is confirmed by the following message on the service display after the STORE key has been released:

REP/SYNC PARAM A>B SUCCESSFULLY COPIED
-------------------------------------------

### 1.7.7 Description of the menu window in the audio key programming branch

---

#### Audio functions that can only be program assigned to a key:

**Display shows:**

F101 1/0	no key
REHEARSE	

**Functional description:**

REHEARSE is used for simulating punch-in/punch-out operations. When REHEARSE is active, the machine behaves in record mode as if a recording were made, except that no recording takes place. Instead the channels switched to READY and SYNC switch to input at the punch-in point and back to SYNC at the punch-out point. The PLAY and REC LEDs flash.  
Precondition: F044 IN-OUT DELAY must be active!

F102	no key
SPOT ERASE	

Speaker errors, switching clicks, etc. can be erases locally. SPOT ERASE is activated by pressing the following keys:

- EDIT
- SPOT ERASE; the status indicator lamp is light during 4-5 s; during this time:
- EDIT + REC must be pressed simultaneously.

The erase heads of the channels preselected with READY are activated. These tracks can be erased manually by shuttling the tape by hand in front of the head.

The active SPOT ERASE mode is indicated by the flashing REC and EDIT keys.

F104	Loc.k31
AUDIO REMOTE IF	

ON: LED is light, only the AUDIO PARALLEL IF Connection (Neutrik socket on the connector panel) is active.

OFF: LED is dark, the Connections AUDIO PARALLEL IF (Neutrik socket on the connector panel) as well as the AUDIO REMOTE (D-type connector on the connector panel) are active.

### 1.7.8 Description of the menu windows in the tape deck key and function programming branch

---

#### Tape deck functions that can be program assigned to a key directly in the menu window:

**Display shows:**

F201 1/0	no key
TAPE GUARD A NO/RED	

**Functional description:**

From the difference in the rotational speed between the two reels the machine detects that only a few turns of tape are left on the supply reel.

F202 1/0	no key
TAPE GUARD B NO/STOP	

RED: Reduces the spooling speed shortly before the tape unthreads. The winding speed can be increased again by pressing the the corresponding spooling key.

STOP: The spooling process is stopped shortly before the tape unthreads.

NO: The spooling speed is not reduced, i.e. the spooling operation is not stopped before the tape unthreads (F201/F202).



F212	1/0	no key
7.5 IPS		Y/N

**Speed selection**

F211–F214: One speed per key  
 F215–F217: Changeover between 2 speeds per key  
 F218–F219: Changeover between 3 keys per key  
 F220: Changeover between 4 speeds per key.

**Speed assignment:**

F211: \* 3.75 ips  
 F212: 7.5 ips Loc.k25  
 F213: 15 ips Loc.k26  
 F214: 30 ips Loc.k27  
 F215: \* 3.75 / 7.5 ips no key  
 F216: 7.5 / 15 ips no key  
 F217: 15 / 30 ips no key  
 F218: \* 3.75 / 15 / 30 ips no key  
 F219: 7.5 / 15 / 30 ips no key  
 F220: \* 3.75 / 7.5 / 15 / 30 ips no key

\* At 3.75 ips the audio parameters and time constants for 7.5 ips record/reproduce are used!

F230	1/0	no key
FADER MASTER EN		Y/N

When FADER MASTER is switched off (0/1), FADER START cannot be activated. When the tape recorder is operated together with a TLS 4000 synchronizing system, the TLS 4000 switches the FADER function off. In this way the synchronization system gains complete control over the machine. Also refer to the following picture F231...F234.

F231	1/0	no key
FADER A		Y/N

With the FADER START circuit the tape recorder can be remotely switched to play, e.g. with a fader of the mixing console. Other selection possibilities:  
 F232 FADER B no key  
 F233 FADER C no key  
 F234 FADER D no key

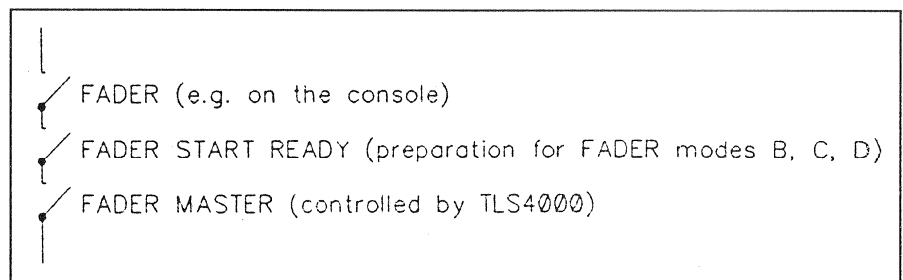
**Fader start mode:**

In the FADER start modes B, C, D the FADER START must be prepared by a local or external switch (FADER START READY) which interconnects pin 6 (SR-FADRY) with pin 1 (ground) of the PARALLEL REMOTE connector.

The FADER START operation is started by applying 5 to 24 V AC or DC between pins 11 and 12 (refer to Section 2.1.4).

The same preparation can be performed with the programmable FADER key (functions F231, F232, F233, F234) on the local keyboard and on the parallel remote control.

Fader mode		A	B	C	D
	FADER READY key required		■	■	■
	FADER READY key not required	■			
<b>Fader closed:</b>	Tape deck operable	■	■		■
	Tape deck keys inhibited			■	
<b>Fader open:</b>	Tape deck operable				■
	Tape deck keys inhibited	■	■	■	

<sup>9</sup>  

F241 1/0	no key
VS DISP FORM %	Y/N

Y: The varispeed deviation is indicated in percent of the nominal play speed.  
 N: Function not active.

<sup>9</sup>  

F242 1/0	no key
VS DISP FORM HT	Y/N

Y: The varispeed deviation from the nominal speed is indicated in semitones.  
 N: Function not active.

<sup>9</sup>  

F243 1/0	no key
VS DISP FORM IPS	Y/N

Y: The varispeed deviation from the nominal speed is indicated as the absolute speed.  
 N: Function not active.

<sup>9</sup>  

F244 1/0	no key
VS D. FORM IPS/HT/%	

Each time the key is pressed the next of the 3 possible VARISPEED display modes is selected.

F245 1/0	no key
VS IND. ENHANCED	Y/N

Y: The active state of the varispeed function is signalled by the two flashing spooling status indicator lamps. This is particularly useful if the A827 MCH is operated only via the remote control without additional status indicator lamps.  
 N: Function switched off.

F246 1/0	no key
SAVE KEY SETTING	Y/N

Y: The customer specific programming of the keys is retained.  
 N: The programming of the function keys is automatically adapted to the changed conditions, e.g. when the machine is converted from 2" to 1" tape.

F247 1/0	no key
PROGRAM DISABLE	A/B

A: The closed programming lock (enable key 46 refer to p. 1/4) denies access to the menu.  
 B: The closed programming lock (enable key 46 refer to p. 1/4) allows the following menu accesses:  
 ■ SET LIBRARY WIND SPEED  
 ■ SET MAX. WIND SPEED  
 ■ SET ROLLBACK TIME  
 ■ SET MAX. REEL DIAMETER

It is not possible to program a key function as long as the programming lock is set. Any attempt will be signalled on the service display with the message "program mode not enabled". For resetting the programming lock the enable key 46 (p. 1/4) must be pressed.

<sup>9</sup>When the machine is powered on the last selected varispeed display mode is reestablished.

F252 1/0	no key
SHUTTLE MODE A/B	

Selection function for the tape/head contact in SHUTTLE mode.

A: In SHUTTLE mode there is contact between the tape and the head.

B: In SHUTTLE mode the tape is lifted off the head.

The SHUTTLE operation can only be performed via the autolocator or the serial control.

F253 1/0	no key
WIND MODE A/B	

A: The tape lift pin lifts the tape off the soundhead in spooling mode.

B: The tape does not contact the tape lift pin in spooling mode (gentle tape handling). The pinch roller assembly is fully disengaged.

F254 1/0	no key
EDIT MODE A/B	

A: In EDIT mode the tape tension control is active (one-handed cueing possible)

B: No tape tension in edit mode.

F255 1/0	no key
REC INDIC MODE A/B	

A: The record status feedback on the tape deck key [5] is only active if at least 1 channel is switched to record (exception: when READY RECORD F059 is set to Y (active).

B: The record status feedback on the tape deck key [5] is independent of the recording status of the audio section.

Application: "Follow external record" with TLS 4000.

F257 1/0	no key
LIFTER REMOTE A/B	

Determines the lifter function on the **parallel remote control**.

A: The status of the audio channel (INPUT, REPRO, SYNC) is not influenced when the LIFTER function is activated (F332)<sup>10</sup>.

Application: Reading the time code in spooling mode.

B: When AUTOINPUT is selected, the audio channels set to READY are switched back from INPUT to SYNC as soon as the LIFTER function is activated.

Application: Cueing of the audio channels in spooling mode.

Also see functions LIFTER F332 and AUTOINPUT F052.

F258 1/0	no key
LIFTER LOCAL A/B	

Determines the lifter function on the A827 MCH and on the serial remote control.

A: The status of the audio channel (INPUT, REPRO, SYNC) is not influenced when the LIFTER function is activated (F332)<sup>11</sup>.

Application: Reading the time code in spooling mode.

B: When AUTOINPUT is selected, the audio channels set to READY are switched back from INPUT to SYNC as soon as the LIFTER function is activated.

Application: Cueing of the audio channels in spooling mode.

Also see functions LIFTER F332, AUTOINPUT F052 and F260 as well.

F259 1/0	no key
SINGLE LOOP MODE A/B	

For LOOP mode without numeric input of an end address.

A: The SINGLE LOOP key **on the autolocator** functions as an instant loop.

B: The SINGLE LOOP key **on the autolocator** functions as a single loop.

#### Explanation of single loop:

An single loop selected on the autolocator is executed.

#### Explanation of instant loop:

The loc position selected on the autolocator or LOC1 represents the starting or ending address. When the INSTANT LOOP key is pressed, the machine spools forward or backward to the starting or ending address. The loop is repeated until cancelled.

<sup>10</sup>If automute is activated (key [35]), all audio channels except the time code channel are muted.

<sup>11</sup>If automute is activated (key [35]), all audio channels except the time code channel are muted.

F260 1/0	no key
LIFTER POSITION	A/B

In lifter mode you can select, whether or not the tape should make head contact. This function is principally used for post production work.

A: In lifter mode the tape makes contact with the soundhead

B: In lifter mode the tape is lifted off the soundhead to prevent contact

F265 0/1	no key
AUTO LOAD ENABLE	Y/N

AUTO LOAD is used for automatically programming the punch-in and punch-out addresses on the autolocator in AUTOREC mode. The addresses are entered by pressing REC or PLAY.

Y: Assigns the AUTO LOAD function is assigned to the TRANS/REV PLAY function key on the autolocator.

N: Cancels the AUTO LOAD function of the TRANS/REV PLAY key on the autolocator is canceled.

## 1.7.9 Description of the menu windows in the tape deck key programming branch

### Tape deck functions that can only be program assigned to a key:

#### Display shows:

F301	L07,R06
REWIND	

#### Functional description:

Rewinding with the programmed spooling speed.

The spooling speed can be defined in the ALIGNMENT DECK block.

Basic programming: 15 m/s.

F302	L06,R05
FORWARD	

Fast forward with the programmed spooling speed.

The spooling speed can be defined in the ALIGNMENT DECK block.

Basic programming: 15 m/s.

F303	no key
LIBRARY WIND	

Library wind can be activated either with a correspondingly programmed key or by pressing SHIFT and one of the spooling keys.

When this function is active, the tape is wound with the reduced, programmable (0.1 to 15 m/s) spooling speed.

The spooling speed can be defined in the ALIGNMENT DECK block, basic programming: 5 m/s.

F304	L05,R04
PLAY	

Playback with the selected tape speed.

SHIFT + PLAY pressed simultaneously = REVERSE PLAY

F305	no key
REVERSE PLAY	

Playback in the reverse direction can be activated either with a correspondingly programmed key or by pressing SHIFT + PLAY

F306	L04,R03
STOP	

STOP interrupts all tape deck functions.

When STOP + LOC 1-5 are pressed simultaneously, the stored tape address is displayed on the tape timer.

F307	L03,R02
RECORD A	

To switch the machine to record mode, PLAY + REC must be pressed simultaneously.

Delay compensated drop-out by pressing PLAY. Recording in RECORD A mode is not feasible if:

- MASTER SAFE is activated
- NO channel is switched to READY
- F059 READY RECORD is deselected (NO)

F308 RECORD B	no key
------------------	--------

If the machine is already switched to record, the record mode can be activated by pressing only the REC key (drop-in).

Delay compensated drop-out by pressing PLAY.

Recording in RECORD B mode is not feasible if:

- MASTER SAFE is activated
- NO channel is switched to READY
- F059 READY RECORD is deselected (NO)

F309 EDIT	Loc.k02
--------------	---------

Activates one-handed CUEING (tape brakes released).

(Also see: Playing a cut tape segment, Section 1.6.11).

F311 TRANSFER/SHIFT	L20, R26
------------------------	----------

Changeover key:

- SHIFT + LOC 1-5 = Stores the current tape address in the selected LOC memory.
- SHIFT + PLAY = Reverse play
- SHIFT + REC + PLAY = Reverse record
- SHIFT + ◀/▶ = Library wind in the selected direction

F312 HOLD	no key
--------------	--------

Freezes the current tape timer reading (also LAP mode). However, the tape timer continues to run internally.

The frozen tape address can be stored as the locate address by pressing a LOC key. The tape timer display then continues to run normally (HOLD indicator switches off). When the same LOC key is pressed again, the stored tape address is automatically searched.

F313 LOC1	L22, R25
--------------	----------

The LOC 1-5 functions are used for automatically searching the stored addresses. PLAY + REC can be preselected while the machine is searching. The keys of the preselected function flashes until the LOC address has been found.

F314 LOC2	L22, R25
--------------	----------

F315 LOC3	L22, R25
--------------	----------

Recall of the LOC address on the tape timer display is possible by simultaneously pressing the STOP key and the corresponding LOC key, or while a tape address is being searched by continuously pressing the corresponding LOC key.

F316 LOC4	L22, R25
--------------	----------

F317 LOC5	L22, R25
--------------	----------

All LOC addresses remain stored when the machine is switched off.

F318 LOC ZERO	L21, R22
------------------	----------

Automatic search of the address 0.00.00 (also LAP). PLAY + REC can be preselected while the machine is searching. The keys of the preselected function flashes until the LOC ZERO address has been found.

F319 LOC START PLAY	L23, R21
------------------------	----------

Automatic search of the address at which the last PLAY or RECORD command was entered when the tape was standing still. When the address is reached, the machine switches automatically to PLAY. STOP or REC can be preselected while the machine is searching. The key of the preselected function flashes until the LOC START address has been found.

F320 LOC START STOP	L23, R21
------------------------	----------

Automatic search of the address at which the last PLAY or RECORD command was entered when the tape was standing still. When the address is reached the machine switches automatically to RECORD. PLAY or STOP can be preselected while the machine is searching. The keys of the preselected function flashes until the LOC START address has been found.

F321 L23,R21  
LOC START REC

Automatic search of the address at which the last PLAY or RECORD command was entered when the tape was standing still. When the address is reached, the machine switches automatically to STOP.

The key of the preselected function flashes until the LOC START address has been found.

F322 Rem.k20  
ROLLBACK PLAY

The tape is rolled back automatically from the current tape address by the specified amount.

The ROLLBACK time is defined in the ALIGNMENT DECK branch under SET ROLLBACK TIME.

As soon as the target address is reached the PLAY command is automatically executed.

F323 Rem.k20  
ROLLBACK STOP

The tape is rolled back automatically from the current tape address by the specified amount.

The ROLLBACK time is defined in the ALIGNMENT DECK branch under SET ROLLBACK TIME.

As soon as the target address is reached the STOP function is automatically activated.

F324 Rem.k20  
ROLLBACK RECORD

The tape is rolled back automatically from the current tape address by the specified amount.

The ROLLBACK time is defined in the ALIGNMENT DECK branch under SET ROLLBACK TIME.

As soon as the target address is reached the RECORD command is automatically executed.

F325 no key  
BACKSPACE STOP

With this cueing function the tape can be rewound with head contact at four times the play speed. This function is only active for as long as the key is pressed. Release the key activates a STOP or with Function F336 a Play command.

F326 no key  
BACKSPACE PLAY

The following modes can be selected with the functions F327-F330:

Dump edit modes (F327-F330):	A	B	C	D
	F327	F328	F329	F330
Tape timer active	■		■	
Tape timer switched off		■		■
Direct selection key TAPE DUMP (cancel with STOP or TAPE DUMP)	■	■		
Preselection key TAPE DUMP Function is activated with PLAY (interrupted with STOP)			■	■

F327 no key  
TAPE DUMP A

F328 no key  
TAPE DUMP B

F329 no key  
TAPE DUMP C

F330 no key  
TAPE DUMP D

F332 no key  
LIFTER

The tape can be cued for as long as this key is pressed.

Also refer to the functions LIFTER REMOTE A/B F257, LIFTER LOCAL A/B F258 and LIFTER POSITION A/B F260.

If F041 AUTO MUTE ON is selected, the mute function is suspended as soon as the LIFTER key is pressed.

F334 Rem.k40  
LAP/WATCH DISPLAY

Switches the display to a second timer (LAP). When LAP/WATCH is active, the letter "L" is displayed in the first position of the tape timer. Since both timers are operated in parallel, the LAP timer can be set to zero without affecting the main timer. IN LAP/WATCH mode also the LOC ZERO function relates to the zero position of the LAP/WATCH timer.

F335 L10,R41  
RESET TIMER

Key for resetting the main timer or the LAP/WATCH timer. Only the tape timer currently visible on the display will be reset. The timer remains at zero for as long as this key is pressed.

F336 Loc.k11  
SET TIMER

Function for changing the content of the tape or LAP timer. The hours.min.sec are visible on the service display. With the cursor keys </> the cursor can be positioned below the desired unit of time. The figures are changed by pressing the UP/DOWN keys. The changed tape timer reading can be saved by pressing the STORE key.

F337 Loc.k12  
SET ADDRESS

Function for entering locator addresses. The hours.min.sec are visible on the service display. With the cursor keys </> the cursor can be positioned below the desired unit of time. The figures are changed by pressing the UP/DOWN keys. The changed tape timer reading can be stored in a locator register by pressing the SHIFT + LOC 1-5 key.

F338 Loc.k41  
SET VARISPEED

Function for setting a tape speed. The service display shows the deviation from the nominal tape speed. The displayed value can be modified with the UP and DOWN keys. The new value is stored by pressing SET VARISPEED. The display format can be selected with the functions F241-F244.

F339 Loc.k40  
VARISPEED ON/OFF

Activates the variable tape speed. Switches the service display to VARISPEED. The deviation from the nominal tape speed is displayed in the selected format. In addition the VARISPEED status indicator lamp flashes. Varispeed can also be activated in the reverse play mode.

The kind of displaying the tape speed deviation is defined with F241...F244 VARISPEED DISPLAY FORMAT.

If SET VARISPEED is selected in addition to VARISPEED, the tape speed can be changed with the UP/DOWN keys in normal or reverse play mode.

Enable key for the local and/or remote control keyboard. Two operating modes can be programmed with F345/F346:

F345  
REMOTE A R. CONT. ONLY

F346  
REMOTE B REM + LOCAL

Programming	Rem.A Only Remote Control		Rem.B Remote Control + Local		None active <sup>12</sup>
	Selected <sup>13</sup>	Deselected <sup>14</sup>	Selected <sup>13</sup>	Deselected <sup>14</sup>	
Local keyboard active	-	■	■	■	■
Remote control parallel, serial and RS232 <sup>15</sup> inactive	■	-	■	-	■

Note: TD REM can only be selected in STOP mode.  
TD REM even switches the RS232 commands on and off!

<sup>12</sup>Neither Remote A nor Remote B are active, that means F345 and F346 are "NO" set.

<sup>13</sup>Yellow LED lit.

<sup>14</sup>Yellow LED doesn't lit.

<sup>15</sup>In conjunction with the TLS4000 the remote control must be selected!

F347 SHUTTLE BAR	Rem. k20
---------------------	----------

Key for storing the SHUTTLE speed that has been selected with the SHUTTLE when on the autolocator.  
This function can be activated while the SHUTTLE wheel is being operated.  
Resettable with all tape deck commands, LOC and ROLLBACK functions.

F348 UNLOAD	Loc. k24
----------------	----------

Key for disengaging the pinch roller assembly

F351 NO FUNCTION	no key
---------------------	--------

Function for programming a dummy key (key without a function)

**Loop functions:**

F355 SINGLE LOOP	no key
---------------------	--------

Operated from the tape deck or serial remote control:  
A single loop between the LOC1 and LOC2 register is executed.  
Operated from the autolocator:  
A single loop between any two selectable locator registers (max. 20) is executed.

F356 AUTO LOOP	no key
-------------------	--------

Operated from the tape deck or the serial remote control:  
An endless loop between the LOC1 and LOC2 register is executed.  
Operated from the autolocator:  
An endless loop between any two selectable locator registers (max. 20) is executed.

F357 INSTANT LOOP	no key
----------------------	--------

An endless loop between LOC1 and the timer content active at the moment the INSTANT LOOP key is pressed will be executed. The smaller of these two values is taken as the starting address.

**INSTANT LOOP-key determines the beginning of the loop**

**Examples:**

- LOC1 register contains e.g. 0.05.00
- The machine is parked at 0.001.00
- Press the PLAY key or directly the INSTANT LOOP key. The machine runs in PLAY mode up to the LOC1 address and then rewinds to the INSTANT LOOP position.

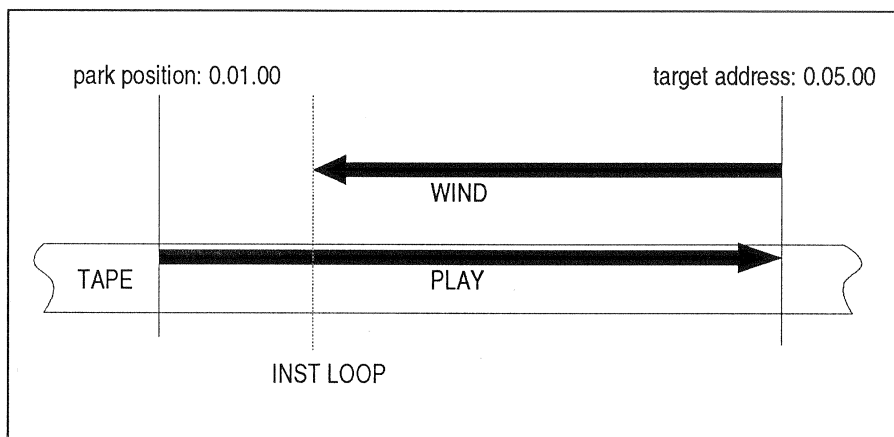



**INSTANT LOOP-key determines the end of the loop**

- Loading the park position with the SHIFT and LOC1 keys into the LOC 1 register (e.g. 0.01.00)
- Press the PLAY key.
- Press INSTANT LOOP at the desired tape address in order to define the end of the loop (e.g. at 5 min)

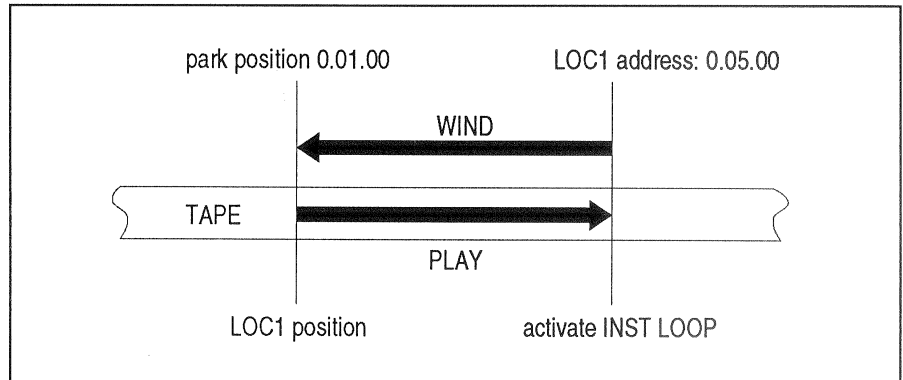

When activated, INST LOOP is automatically taken as the target address.

**Shortening the loop**

The loop can be shortened by any amount and as often as desired by pressing INSTANT LOOP again.

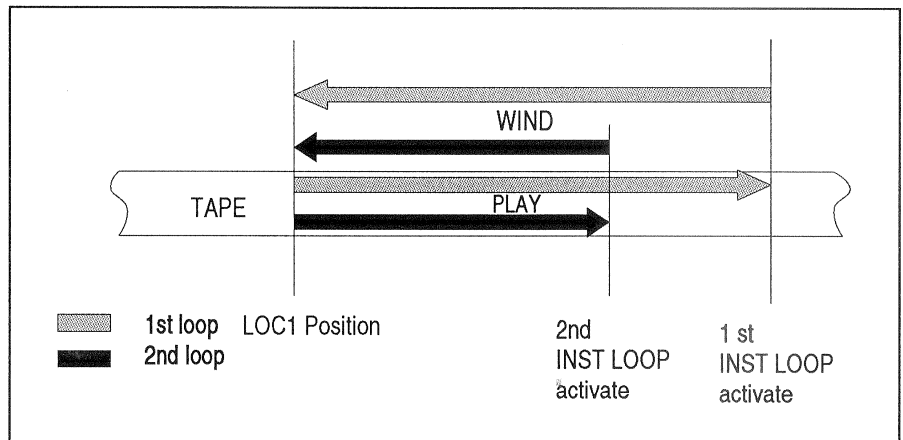

1.7.10 Tree Diagram Software 16/97

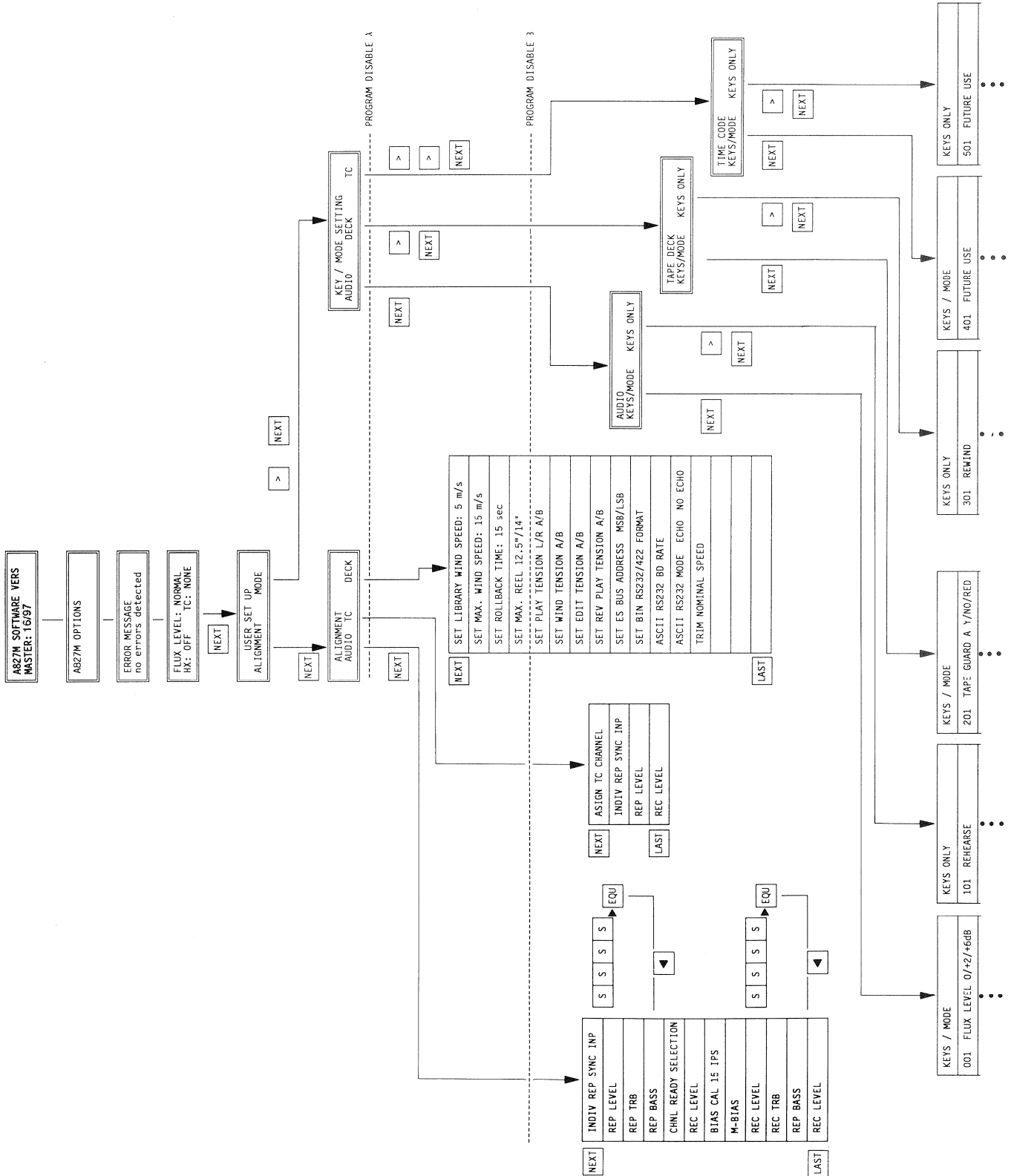

KEYS / MODE	KEYS ONLY	KEYS / MODE	KEYS ONLY	KEYS / MODE	KEYS ONLY	KEYS / MODE	KEYS ONLY
001 FLUX LEVEL 0/+2/-6dB	101 REHEARSE	201 TAPE GUARD A Y/NO/RED	301 REWIND	401 FUTURE USE	501 FUTURE USE		
021 MASTER SAFE Y/N	102 SPOT ERASE	202 TAPE GUARD B NO/STOP	302 FORWARD				
022 TAPE A	104 AUDIO REMOTE IF	211 3.75 IPS Y/N	303 LIBRARY WIND				
023 TAPE B		212 7.5 IPS Y/N	304 PLAY				
024 TAPE A/B		213 15 IPS Y/N	305 REVERSE PLAY				
029 CCIR		214 30 IPS Y/N	306 STOP				
030 NAB		215 3.75/7.5 IPS	307 RECORD A				
032 CCIR/NAB		216 7.5/15 IPS	308 RECORD B				
041 AUTO MUTE ON/OFF		217 15/30 IPS	309 EDIT				
044 IN-OUT DEL. Y/N		218 3.75/7.5/15 IPS	311 TRANSFER / SHIFT				
047 HX PRO A/B/C/D		219 7.5/15/30 IPS	312 HOLD				
052 AUTO INPUT A/B		220 3.75/7.5/15/30 ips	313 LOCATE 1				
054 MRS DOLBY/TELCOM		230 FADER MASTER ENABLE	314 LOCATE 2				
059 READY RECORD Y/N		231 FADER A Y/N	315 LOCATE 3				
061 DROP-OUT DELAY Y/N		232 FADER B Y/N	316 LOCATE 4				
062 AUTO INPUT Y/N		233 FADER C Y/N	317 LOCATE 5				
071 COPY REP/SYM PAR 7.5		234 FADER D Y/N	318 LOCATE ZERO				
072 COPY REP/SYM PAR 15.0		241 VARISPEED %	319 LOC START PLAY				
073 COPY REP/SYM PAR 30.0		242 VARISPEED HT	320 LOC START STOP				
		243 VARISPEED IPS	321 LOC START REC				
		244 *- %/IPS/HT/%	322 ROLLBACK PLAY				
		245 *- IND. ENHANCED Y/N	323 ROLLBACK STOP				
		246 SAVE KEY SETTING Y/N	324 ROLLBACK REC				
		247 PROGRAMM DISABLE A/B	325 BACKSPACE STOP				
		252 SHUTTLE MODE A/B	326 BACKSPACE PLAY				
		253 WIND Mode A/B	327 TAPE DUMP A				
		254 EDIT Mode A/B	328 TAPE DUMP B				
		255 REC. INDIC. MODE A/B	329 TAPE DUMP C				
		257 LIFTER REMOTE A/B	330 TAPE DUMP D				
		258 LIFTER LOCAL A/B	332 LIFTER				
		259 SINGLE LOOP MODE A/B	334 LAP/MATCH DISPLAY				
		260 LIFTER POS. A/B	335 RESET TIMER				
		265 AUTO LOAD Y/N	336 SET TIMER				
			337 SET ADDRESS				
			338 SET VARISPEED				
			339 VARISPEED ON/OFF				
			345 REMOTE A REM.CTL.ONLY				
			346 REMOTE B REM + LOCAL				
			347 SHUTTLE BAR				
			348 UNLOAD				
			351 NO FUNCTION				
			355 SINGLE LOOP				
			356 AUTO LOOP				
			357 INSTANT LOOP				

DOWN

UP

DOWN

UP

## 1.8 Operating the audio remote control

### 1.8.1 Introduction

The audio remote control is required for operating the A827 multichannel machine because there are no controls for individual channel selection. For multichannel recordings and mixdown the audio remote control is a useful instrument.

When the remote control is located at or near the mixing console, the outputs can be completely remote controlled either individually or via the master keys, varispeed, locator and other functions.

### 1.8.2 Connecting the audio remote control to the A827 MCH

- Switch the tape recorder off.
- With the supplied cable (15 m) connect the audio REMOTE to the AUDIO REMOTE socket on the tape recorder.
- Switch the tape recorder on.
- On the tape deck press the function TD REM so that also the audio functions can be operated via the AUDIO REMOTE CONTROL. All other functions remain active when the RD REM function is switched off.
- The audio remote control is now ready for operation.

**Important:** The REM IF key must be deselected.

#### Connecting a second audio remote control to the A827 MCH:

For connecting a 2nd audio remote control a 37-pole Y cable is required. The two audio remote controls are then working in parallel mode.

**Important:** On the additional audio remote control the DIL switch 1 (on Basis Board 1.820.705.20) must be switched over. Leave the DIL switch settings of the 1st audio remote control as they were.

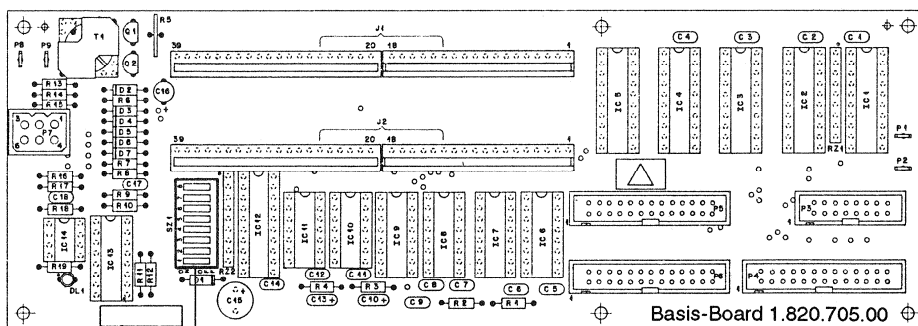

(Part of the audio-remote box 1.328.523.81)

Standard DIL switch setting on the 1st audio remote control

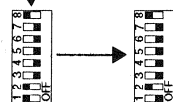

DIL switch setting on the additional audio remote control



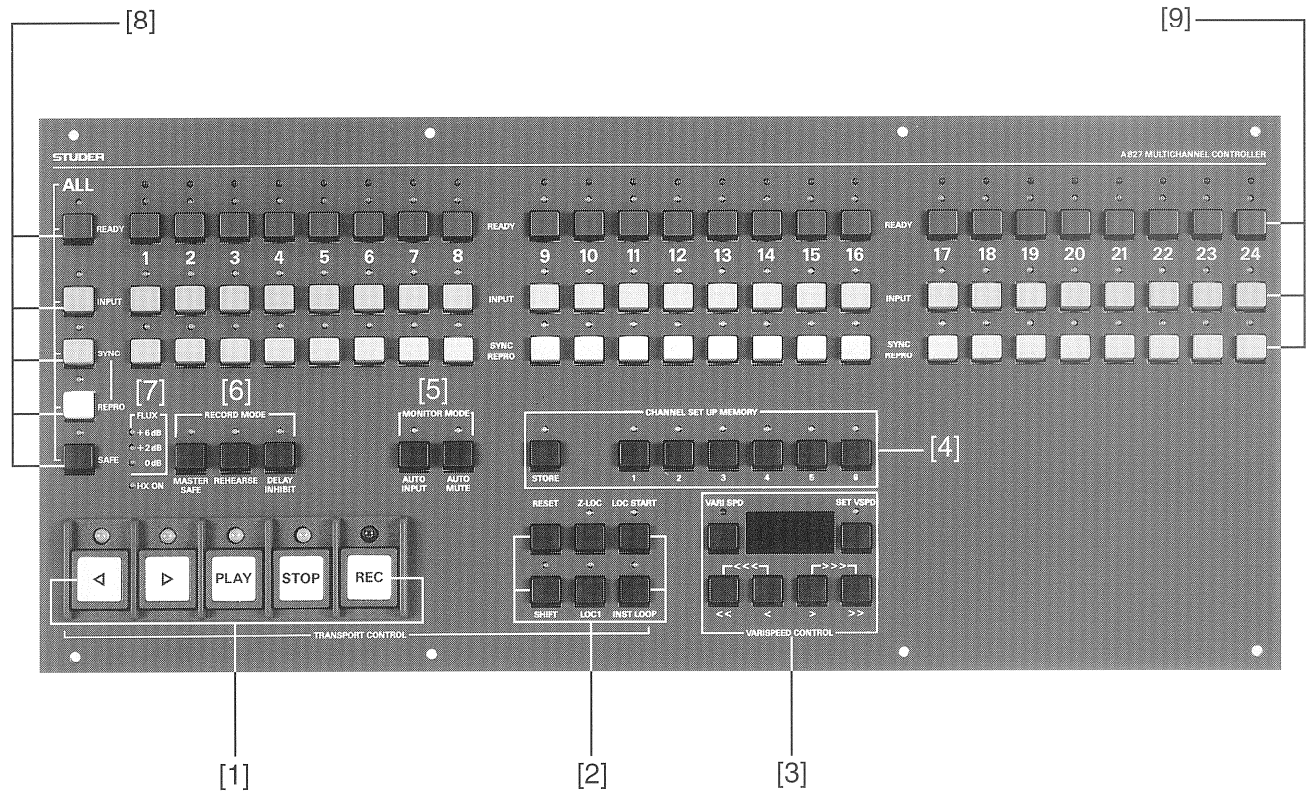



## 1.8.3 Operator controls and status indicators



- [1] Basic tape deck functions
- PLAY
  - REC
  - STOP
  - WIND
- [2] Keypad for operating the:
- LOCATE and LOOP functions
  - Tape timer RESET
- [3] Keypad for operating the variable tape speed with indicator LED.
- Indication in semitones
  - Adjustment range  $\pm 7$  semitones
- [4] Keypad for storing 6 different channel settings
- [5] Keys for selecting AUTO INPUT and AUTO MUTE.
- [6] Record mode function keys:
- MASTER SAFE
  - REHEARSE
  - DELAY INHIBIT
- [7] LEDs for indicating the selected tape flux and DOLBY HX PRO.
- [8] MASTER functions of all channel selection keys:
- READY
  - INPUT
  - SYNCH
  - REPRO
  - SAFE
- [9] Individual output selectors for the functions:
- READY
  - INPUT
  - SYNC/REPRO

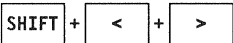

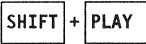
### 1.8.4 Basic tape deck functions [1]

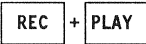
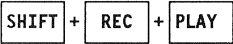
---

Key:	Function:
	Spooling forward (The spooling speed can be programmed on the tape deck)
	Spooling backward (The spooling speed can be programmed on the tape deck)
	Library wind (the library wind speed programmed on the tape deck is selected)
	Forward play
	Reverse play
	The stop function has priority over all other tape deck functions and cancels the loop mode.
	The record key is only effective together with PLAY (if at least one channel is switched to READY). In play mode, record is activated either directly by pressing REC (F308: record B), or by pressing REC+PLAY (F307: record A), depending on how the tape deck is programmed.
	Reverse record (erase head switched off)

### 1.8.5 Keypad for the functions LOCATE, LOOP and RESET [2]

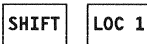
---

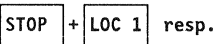
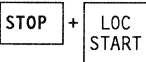
Key:	Function:
	Preparatory key for storing a tape address in the LOC 1 register; the current tape address is stored by pressing the LCO 1 key.  Input: 
	Automatic search of the last tape address that has been stored with SHIFT. The LOCATE address is shown on the tape timer display as long as this key is pressed.
 resp.	Displays the stored address (tape position).
	

INST  
LOOP

This key activates a LOOP without numeric input of an end address, also refer to INST LOOP, Section 1.7.9.

**Example:** Start the recorder in PLAY mode, set the start address and press the SHIFT and LOC1 key simultaneously. When the desired end position is reached, an endless loop can be started by pressing the INSTANT LOOP key.

LOC  
START

Automatic search of the tape address at which the last PLAY or RECORD command was entered when the tape was standing still. Depending on the programming of the tape deck the machine subsequently switches to PLAY, STOP or RECORD (F319: LOC START PLAY; F320: LOC START STOP; F321: LOC START REC).

Z-LOC

Automatic search to the tape address that corresponds to the tape timer reading 0.00.00

RESET

Key for resetting the tape timer display to 0.00.00

### 1.8.6 Keypad for the varispeed functions [3]

**Key:**

**Function:**

VARI  
SPD

Selection key for the variable tape speed. When this key is pressed the red LED above the key flashes; the tape deck switches to the speed selected with SET VSPD.

On the 3-position LED display the change of the tape speed is shown in semitones.

**Note:** The following message appears on the LC display of the tape recorder:

EXTERNAL VARISPEED  
ACTIVE

SET  
VSPD

Selection key for entering the variable tape speed. When the yellow LED above the key is light, the desired tape speed can be selected with the << and < or > and >> key. The small display shows the set deviation from the nominal speed in semitones.

After the desired deviation has been set, the set varispeed function must be switched off by pressing the SET VSPD key again. The yellow LED above the key is switched off and the value is stored.

SET  
VSPD + <

Slow reduction of the tape speed while the SET VSPD function is active.

SET  
VSPS + <<

Fast reduction of the tape speed.

SET  
VSPS + >

Slow increase of the tape speed while the SET VSPD function is active.

SET  
VSPS + >>

Fast increase of the tape speed.

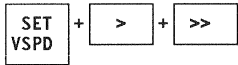

If both keys > and >> are pressed simultaneously, the tape speed can be increased very rapidly [> > >].

## Varispeed priorities:

This VARISPEED key has priority over all varispeed selection possibilities:

- Internal varispeed
- Varispeed from the autolocator
- Varispeed unit on the parallel remote control connector

## Important!

- When varispeed is selected on the audio remote control, the following information is shown on the service display [9] of the A827:

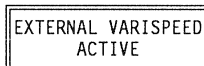

In this case the varispeed function cannot be deselected with the internal VARISPEED [29] key or from the autolocator.

- The variable tape speed selection on the audio remote control is independent of the varispeed set internally in the equipment, i.e. two different varispeeds can be preselected.
- When the VARISPEED [29] key on the A827 or the V-SPEED key on the autolocator is pressed, the speed shown on the LC-display [9] is set.
- When VARISPEED is selected on the audio remote control, the speed setting supplied by the audio remote control is immediately followed, regardless of whether the A827 was operating with:
  - Nominal play speed
  - Internal varispeed
  - External varispeed or
  - Varispeed on the autolocator

## 1.8.7 Keypad for storing various channel settings [4]

---

### Key:

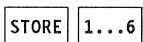

### Function:

Store key for 6 registers. The current channel setting can be transferred into a memory by pressing the desired memory key (1...6) after STORE has been pressed.

Six registers are available for storing 6 different channel settings.

By pressing one of the six register keys the correspond channel setting will be activated.

- Note:** In READY RECORD F059 "YES" mode (direct punch-in), all channels that are in READY mode switch automatically to record when the corresponding memory is accessed.



### 1.8.8 Keys for the monitor mode functions [5]

Key:	Function:
<div style="border: 1px solid black; padding: 2px; width: fit-content;">AUTO INPUT</div>	<p>Automatic through-connection of the input signal: All channels switched to SYNC (AUTO INPUT A) or SYNC and READY (AUTO INPUT B) are switched to INPUT in the operating modes:</p> <ul style="list-style-type: none"> <li>- STOP</li> <li>- WIND</li> <li>- LOC</li> </ul> <p>The AUTO INPUT mode can be programmed on the tape recorder; F052 AUTO INPUT A/B.</p>
<div style="border: 1px solid black; padding: 2px; width: fit-content;">AUTO MUTE</div>	<p>Automatic muting:</p> <ul style="list-style-type: none"> <li>- In spooling mode. Exception: In LIFTER MODE A/B (Automute not activated).</li> <li>- During the acceleration phase until the nominal tape speed is reached.</li> </ul>

### 1.8.9 Keys for the record mode functions [6]

Key:	Function:
<div style="border: 1px solid black; padding: 2px; width: fit-content;">MASTER SAFE</div>	<p>Record inhibition This function switches all channels to SAFE. The READY keys are switched off. Recording is not possible as long as MASTER SAFE is pressed. (If this key is pressed while a recording is in progress, all channels immediately drop out of record mode).</p>
<div style="border: 1px solid black; padding: 2px; width: fit-content;">REHEARSE</div>	<p>Record simulation With this function it is possible to electronically simulate a tape edit function. After the preselection key REHEARSE has been pressed, the LED of the PLAY key flashes in play mode. When REC+PLAY (REC and PLAY LEDs flash) is selected, the tape deck switches from SYNC to INPUT at the precise moment, however, without switching to record. When the PLAY key is pressed the machine switches back to SYNC. <b>Preconditions for REHEARSE:</b> The affected channel must set to SYNC and READY and DELAY INHIBIT must be switched off. This function can be cancelled by pressing the REHEARSE key again.</p>
<div style="border: 1px solid black; padding: 2px; width: fit-content;">DELAY INHIBIT</div>	<p>Time delay compensation. This key cancels the delayed drop-in/out of the record head relative to the erase head in punch-in/out operations.</p> <ul style="list-style-type: none"> <li>■ Key pressed (yellow LED light) = No delay compensation for the record signal, i.e. the erase head and the record head are controlled simultaneously.</li> <li>■ Key not selected (LED is dark) = Staggered on/off switching of the record and erase head.</li> </ul>
<b>Important!</b>	<p>DELAY INHIBIT = OFF is mandatory for the REHEARSE function.</p>

1.8.10 Indicator LEDs for tape flux and Dolby HX [7]

Display:



Function:

These three LEDs indicate the selected tape flux, analogously to the standard picture [9] of the LC display on the A827. However, the FLUX can only be changed on the tape recorder itself (F001).

Example: Nominal tape flux 250 nWb/m

LED indicators on the audio remote control	LC display [9] on the A827	Tape flux
0 dB	FLUXLEVEL: NORMAL	257nWb/m
+2 dB	FLUXLEVEL: +2dB	320nWb/m
+6 dB	FLUXLEVEL: +6dB	514nWb/m



This message indicates whether or not DOLBY HX PRO is switched on. DOLBY HX is a headroom extension that controls the bias level as a function of the high frequencies and their level, in order to prevent oversaturation of the tape. This function can be switched on and off on the tape recorder. Depending on the programming of F407, Dolby HX PRO is simultaneously switched on or off for all channels, or it is controlled as a function of the tape speed.

**LC-display A827:**

LED light = Dolby HX PRO switched on HX: ON  
 LED dark = Dolby HX PRO switch off HX: OFF

1.8.11 ALL keys (Master) [8]

Keys:



Function:

Master record/enable key.  
 All channels are prepared for recording when the green LED above this function key is light.  
 If a channel is programmed for time code, all channels except the TC channel are set to READY.



Master changeover to the input signal.  
 Switches the input signals of all channels directly to the outputs and to the VU-meters of the tape recorder. The yellow LED above the key is light when INPUT is activated.

ALL  
SYNC

Master changeover to the input signal.

Switches the SYNC reproduction signal (from the record head) of all channels to the outputs and to the VU-meters of the tape recorder. The yellow LED above the ALL SYNC key is light when all channels are switched to SYNC.

This mode remains preselected during a recording (REC+PLAY). (As long as the channels work in record mode, they are switched to INPUT, because playback via the record head is not feasible during a recording. Channels which during record mode switch from SYNC to INPUT are restored to SYNC mode when ALL SAFE, READY or PLAY is pressed).

### Note concerning SYNC applications

#### 1. Individual SYNC/REPRO changeover

With the jumper JS 16 on the audio control MPU board 1.827.788.21 the following SYNC/REPRO changeover logic can be set:

**Jumper JS16 installed**

- When ALL SYNC is selected, individual changeover to play (REPRO) is no longer feasible).
- Individual changeover is only possible between SYNC and INPUT.
- Cancellation by pressing ALL REPRO

**Jumper JS16 removed**

- Individual changeover between SYNC and REPRO is always possible.

#### 2. SYNC drop-out time

Jumper JS 10 on the audio control MPU board 1.827.788.21 determines the moment at which the changeover from the INPUT to the SYNC signal takes place when a drop-out occurs.

**Jumper JS10 in position JS10:**

(Short drop-out)

The INPUT signal is not switched off at the same time the RECORD drop-out command occurs. The input signal is through-connected longer and is muted only for approx. 40 ms before the switchback to SYNC. This suppresses switching clicks (No mute since software 10/92).

**Jumper JS10 in JS10/11 position:**

(Long drop mute)

The INPUT signal is switched off at the same time the RECORD drop-out command occurs, i.e. the monitored input signal (INPUT) corresponds exactly to the duration of the signal recorded on tape. However, a longer mute phase must be accepted in this case.

**Note:** For details refer to Section 2.2, "Jumper configuration".

ALL  
REPRO

Master changeover to reproduction

Switches the reproduce signals of all channels to the outputs and to the VU-meters of the tape recorder. The yellow LED above the key is light when all channels are switched to REPRO.

ALL  
SAFE

Master record inhibition

Inhibits recording on all channels. The yellow LED above the key is light. Any flashing READY keys are switched off and the channels operating on record mode drop out.

### 1.8.12 Individual channel and output selection keys

---

Key:

Function:

READY

Record enable key for individual channels.

The corresponding channel is ready for recording when the green LED above the READY key flashes.

When the tape recorder is started in record mode, the red LED above the READY LED lights up.

Recording on the channel can be inhibited by pressing the READY key again = SAFE (LED dark). The channel drops out of an active recording.

**Note:** If the GROUP SELECT function (F059) is programmed as NO (standard: YES) on the tape recorder, direct REC drop-in is possible with the READY keys.

**Example:**

- All channels switched to SAFE.
- Start the tape deck with PLAY+REC.
- The desired channels can now be consecutively enabled for recording by pressing the corresponding READY key.

**Important:** If certain channels must switch to record simultaneously:

- The corresponding READY channels must also be pressed absolutely simultaneously,
- or
- the READY selection is programmed with the aid of a CHANNEL SETUP MEMORY [4].

INPUT

Individual changeover to the input signal.

Switches the input signal of the selected channel to the output and to the VU-meters of the tape recorder. The yellow LED above the INPUT key is light.

SYNC  
REPRO

Individual changeover between SYNC reproduction and reproduction.

Switches the SYNC reproduction signal (from the record head) of the corresponding channel to the output and to the VU-meters of the tape recorder. The yellow LED above the orange key is light.

This mode can be preselected for the record function. (As long as the corresponding channel operates in record mode it is switched to INPUT because playback via the record head is not feasible during a recording.) Channels which have been switched from SYNC to INPUT by the record mode are restored to SYNC when the recording operation is terminated.

The yellow LED above the key is light in SYNC mode.

When the SYNC key is pressed again, the corresponding channel is changed over to REPRO; the yellow LED is dark. The reproduce signal is now connected to the output and to the VU-meters.

Source/tape monitoring is possible during a recording by changing over between INPUT and REPRO.

**Note:** If all channels are individually set to the same status, e.g. READY, the master function (ALL READY) is automatically selected when the last channel is selected (e.g. channel 24, or channel 23 if a time code channel is used). When ALL SYNC is active it may no longer be possible to switch the channels individually to REPRO. Refer to ALL SYNC, note 1.

## 1.9 Operation with degraded performance

---

This Section describes the steps to be taken when error occur within a specific module.

- Important:** When an error has occurred, the machine should in all cases be switched off for approx. 10 s and then be switched on again. If the same error reoccurs, proceed according to Section 1.9.1.  
 Operation on a defective unit should only be continued if this is absolutely necessary. The equipment should be repaired or be sent to the nearest STUDER service center.  
 The error list is not complete and can be expanded as required.

### 1.9.1 Error messages on the service display

---

There are three types of error categories:

#### Errors of the category 1

---

- Errors of the category 1 are errors that make the continued operation of the equipment impossible (e.g. hardware defects). Such error messages can only be acknowledged by switching the machine off for approx. 10 s and switching it on again. If the error reoccurs, it should be remedied. If the error disappears the equipment should function correctly.

**Display shows:**

ERR: SUPPLY  
VOLTAGE

**Tape recorder:** Switches to STOP, does not respond to command keys.

**Cause:** One (or several) supply voltages are missing.

**Remedy:** The missing voltage(s) is indicated on the FUSE/SUPPLY VOLTAGE FAILURE DETECTOR 1.820.866.

- Switch off the tape recorder.
- Check the secondary fuses and replace them, if necessary.
- Repair or replace the corresponding SWITCHING STABILIZER board:
  - 1.820.871 ( $\pm 15$  V), or 1.820.873  $\pm 15$  V)
  - 1.820.872 ( $\pm 5.6$  V,  $\pm 27$  V, +24 V)

**Display shows:**

ERR: MASTER DATA  
LOST

**Cause:** Tape tension data lost

- Remedy:**
- Switch the tape recorder off and on again. The default parameters are now loaded. The error message disappears.
  - Check the buffer battery on the MASTER MPU 1.820.784 and replace it, if necessary.
  - Check the supply voltages.

**Display:**

ERR: SPOOLING MOTOR SERVO HARDWARE
---------------------------------------

**Cause:** Error in the analog spooling motor control circuit or missing or open current feedback.**Remedy:** Check the voltage and signals on the following boards:

- Move sensor 1.820.770
- Spooling motor drive amplifier 1.820.875
- Tape tension sensors 1.820.772/1.820.877

## Error messages of the category 2

---

Errors of the category 2 impair the function of the machine, however it can still be operated with degraded performance. Error messages of this category remain on the display for information purposes, even when the cause of the error has disappeared. These error messages can be acknowledged by pressing the STORE key. If the error persists, the same message reappears (and can be acknowledged as described above). The machine can still be operated.

**Display shows:**

ERR: POWER DROP OUT
------------------------

**Tape recorder:** Switches to STOP**Cause:** Transient line voltage failure > 100 ms**Remedy:** Acknowledge with STORE.**Display shows:**

ERR: MOVE-SENSOR HARDWARE
------------------------------

**Tape recorder:** Switches to STOP.**Cause:** MOVE SENSOR PCB 1.820.770 or MOTOR TACHO PCB 1.820.771 defective or too many tape move direction changes detected.**Remedy:** Repair, replacement, realignment (see Sections 3.3.3 and 3.3.11).**Anzeige:**

ERR: SPOOLING MOTOR TACHO RIGHT/LEFT
-----------------------------------------

**Cause:** Right-hand / left-hand spooling tacho motor signals too many direction changes or supplies no signal**Remedy:** Replace , repair or realign (if possible).

### Error messages of the category 3

Errors of the category 3 also influence the function of the machine, however it can still be operated with degraded performance. The error message is automatically cancelled when the cause of the error disappears. If the LC display is needed for other purposes (e.g. varispeed indication), the message can be cancelled by pressing the STORE key, even though the error still exists.

**Display shows:**

ERR: MOTOR SUPPLY  
VOLTAGE LOW

**Cause:** Failure of the spooling motor voltage

**Remedy:** Wait 10 seconds. If the error persists:

- Switch off the tape recorder
- Check the fuses F1 & F2 (next to the power switch) and replace them, if necessary.
- Repair or replace the SPOOLING MOTOR DRIVE AMPLIFIER 1.820.875.

**Display shows:**

ERR: NO COMMUNICAT.  
MASTER-TAPE DECK

**Cause:** ■ No response to the status inquiry.

- Software of the MASTER MPU 1.820.784 not compatible with the TAPE DECK MPU 1.820.781.

**Remedy:** ■ Replace or repair the MASTER SERIAL INTERFACE 1.820.753 and/or the TAPE DECK SERIAL INTERFACE 1.820.763.

**Display shows<sup>2</sup>:**

ERR: NO COMMUNICAT.  
MASTER-AUDIO

**Cause:** ■ No response to the status inquiry.

- The software of the MASTER MPU 1.820.784 and the AUDIO MPU 1.827.782 or 1.827.788 are not compatible.

**Remedy:** ■ Replace or repair the MASTER AUDIO INTERFACE 1.820.756 and/or the COMMUNICATIONS CONTROLLER 1.820.718.

■ Replace the software: 3 EPROMs (IC 15, 16, 18) on each MPU.

**Display shows<sup>2</sup>:**

ERR: AUDIO DATA  
LOST

**Cause:** Audio data lost

**Remedy:** ■ Switch the tape recorder off and on again. The default parameters are loaded and the error message disappears.

■ Check the buffer battery on the AUDIO MPU 1.820.782 and replace it, if necessary.

■ Continue to work with the default parameters (minor deviations from the optimum frequency response are unavoidable), or

■ load the parameters previously recorded on tape, or

■ Recalibrate the tape recorder.

**Display shows:**

ERR: TACHO SENSOR

**Tape recorder:** Switches to STOP

**Cause:** No output signal from one of the three tacho sensors (SPOOLING MOTORS 1.820.771, MOVE SENSOR 1.820.770), the three senses of rotation do not agree, or no tacho signal from the spooling motor with a motor current of > 4A.

- Remedy:**
- Check the flat cable connector to the sensors.
  - Check the sensors and replace or repair them, if necessary.
  - Check that the spindles and the tacho roller rotate without binding.

**Display shows:**

ERR: TAPE TENSION  
CONTROL

**Cause:** Deviation of the tape tension from the reference too large for approx. 1 s.

- Remedy:**
- Clean the tape guide rollers.
  - Check whether the friction of the tape transport and the spindles is too high.
  - Check the tape tensions.

**Display shows:**

ERR: NO COMMUNICAT.  
CAPSTAN-TAPE DECK

**Tape recorder:** Switches to STOP.

- Cause:**
- No data communication via the parallel interface of the CAPSTAN INTERFACE 1.820.727.
  - Capstan processor does not start.
  - Remedy: Replace or repair the CAPSTAN INTERFACE.

**Display shows:**

ERR: INCORRECT  
RADIUS MEASUREMENT

**Tape recorder:** Switches to STOP.

- Cause:**
- The calculated radius of the tape pancake is outside the admissible limits.
  - Tacho sensor defective.

- Remedy:**
- Switch the tape deck (with tape) to PLAY for a few seconds. This message normally disappears as soon as a sufficient number of tacho pulses are available for calculating the pancake radius.
  - Check the tacho sensor and replace it, if necessary.
  - Set the 'max. reel size' in the ALIGNMENT DECK block of the software menu to 14".

**Display shows:**

ERR: REMOTE SHUTTLE  
VALUE HARDWARE

**Cause:** Incorrect values were supplied by the SHUTTLE potentiometer during the initialization phase.

- Remedy:**
- THE SHUTTLE wheel should not be operated during the initialization phase of the machine.
  - Readjust the SHUTTLE potentiometer (see Section 3.3.12).



**Display shows:** ERR: PINCH ROLLER  
SLIPPING

**Tape recorder:** Switches to STOP.

**Cause:** The pinch roller slip is too high; the capstan speed does not agree with the tape speed.

- Remedy:**
- Clean the pinch roller and the capstan shaft; replace the pinch roller if necessary.
  - Adjust the pinching force to the correct value.

**Display shows:** ERR: INCORRECT  
INERTIA

**Tape recorder:** Switches to STOP.

**Cause:** The last three inertia calculations supplied incorrect values.

- Remedy:** Check that the rollers and motors rotate without binding and that the tape moves smoothly across all tape guidance elements and that the reel diameter (MAX. REEL DIAMETER) in the ALIGNMENT DECK block of the software menu is set correctly.

**Display shows:** ERR: TAPE \* NOT  
IDENTIFIED \* or MASTER  
or AUDIO

**Cause:** Unknown error.

- Remedy:**
- Switch the tape recorder off and on again. The machine can be operated normally if the error does not reoccur.
  - Unplug and reinsert the RAM (IC8) of the MASTER MPU 1.820.784.

**Important:** The tape tension data and the key programming will be lost and the default parameters are loaded!

- Continue to operate the machine with the default data,
- load the parameters entered in the log, or
- realign the tape tensions.

**Display shows:** ERR: WRONG HEAD OR  
TAPE SORT

**Cause:** Insufficient memory for reading in the audio parameters.

**Remedy:** Reduce to audio parameters to a total of 48 channels (e.g. 24 channels tape type A+B or 24 channels + 16 channels + 8 channels, etc.).

**Display shows:** ERR: NO DATA FOUND  
ON TAPE

**Cause:** The audio data settings are not readable on tape.

**Remedy:** Check the input signal (level and shape) and the tape speed. The red LED on the COMMUNICATIONS CONTROLLER 1.820.718 should be light.

**Display shows:** ERR: VERIFY FAILED

**Cause:** The audio data settings read from tape do not agree with the machine data.

**Remedy:** Reload the audio data from tape because an error has occurred during the previous loading operation.

**Display shows:**

ERR: HEAD NOT  
IDENTIFIED

**Cause:** Machine powered on without any head block installed, or the identifier code from the Head Assembly Identifier PCB 1.820.795.00 (on head block connector) is wrong.

**Remedy:** Install a head block or check the head assembly identifier PCB.

## Warnings on the service display

---

Warnings are messages of categorie 3.

**Display shows:**

WARN: REFERENCE  
FREQUENCY WRONG

**Tape recorder:** Does not attain the selected nominal tape speed in play mode.

**Cause:** The frequency of the external varispeed reference signal is outside the valid range (6.4 kHz to 14.4 kHz), or the signal is missing.

**Remedy:** Correct the reference signal.

After the conversion of the tape recorder (e.g. from 1" to 2") the audio data and the tape tension parameters are changed automatically. The keypad programming is also adapted.<sup>16</sup> The display shows:

WARN: DEFAULT  
KEYS LOADED

If you want to retain the old keypad programming, the function F246 SAVE KEY SETTING must be activated, i.e. set to YES.

After a data loss (message: ERR: DATA LOST, see above) and after the subsequent on/off switching of the machine, the following message is displayed:

WARN: DEFAULT KEYS  
& PARAMETER LOADED

The machine can still be operated with the default parameters or it must be recalibrated as described above.

- After a key function has been programmed, the display changes to the following message:

WARN: DEFAULT  
PARAMETER LOADED

- After a parameter has been reprogrammed, the display indication disappears.

<sup>16</sup> Compare the key programming with the keypad labels, reprogram if necessary. If all keys have been programmed correctly, reprogram one of the keys to cancel the error message.

## 1.9.2 Error category breakdown via the RS232 (ASCII) interface

Errors are also output via the RS232 interface. The log is maintained in chronological order, i.e. the error that has occurred first will be listed first.

### Setup modes on the A827 MCH:

- Remote B (F346) switched to YES
- RS232 ASCII interface set to ECHO mode ON in "Alignment deck".

Under the above conditions the errors are also displayed in the data status inquiry (RS232 command: DST) and broken down by three categories:

- Master
- Audio
- Tape deck

The error messages are displayed as hexadecimal codes as shown below:

### Master errors (MCH):

01<sub>h</sub>: not used  
 02<sub>h</sub>: not used  
 03<sub>h</sub>: head not identified  
 04<sub>h</sub>: ram checksum error (master data lost)  
 05<sub>h</sub>: no communication master-tape deck  
 06<sub>h</sub>: no communication master-audio  
 07<sub>h</sub>: remote shuttle value invalid  
 08<sub>h</sub>: local shuttle value invalid

### Audio errors (MCH):

01<sub>h</sub>: not used  
 02<sub>h</sub>: not used  
 03<sub>h</sub>: not used  
 04<sub>h</sub>: error in ram (audio data lost)  
 05<sub>h</sub>: audio command not accepted  
 06<sub>h</sub>: wrong head or tape sort  
 07<sub>h</sub>: no data found on tape  
 08<sub>h</sub>: default audio parameter loaded  
 09<sub>h</sub>: verify failed

### Tape deck errors:

01<sub>h</sub>: +5V down  
 02<sub>h</sub>: supply voltage down (summary)  
 03<sub>h</sub>: motor supply voltage down  
 04<sub>h</sub>: tacho sensor error  
 05<sub>h</sub>: tape tension error  
 06<sub>h</sub>: not able to measure radius  
 07<sub>h</sub>: communication error capstan <--> tape deck  
 08<sub>h</sub>: pinch roller slipping  
 09<sub>h</sub>: inertia not measurable  
 0A<sub>h</sub>: reference frequency wrong  
 0B<sub>h</sub>: spooling motor tacho left  
 0C<sub>h</sub>: spooling motor tacho right  
 0D<sub>h</sub>: move sensor hardware error  
 0E<sub>h</sub>: mains voltage out of range (A812)  
 0F<sub>h</sub>: spooling motor servo hardware

### Example of an error indication

On the A827 MCH LC-display:

```
ERR: PINCH ROLLER
      SLIPPING
```

On the terminal via the RS232 ASCII interface:

```
TAPE DECK ERROR: 08
```

## 1.10 Operation with the serial interface

---

Two versions of the serial interface are available:

- Version 1.820.751 supports the operation with a terminal (RS 232, ASCII protocol) and is also required for the communication with the TLS 4000 synchronizer.
- The version 1.820.751 supports the operation with a terminal (RS 422 and RS232, binary protocol). In addition this version is suited for connecting the A827 MCH to an SMPTE/EBU according to the SMPTE standard.

### 1.10.1 SMPTE/EBU bus

---

The SMPTE/EBU bus is a data transmission medium with which several individual units can be joined to a flexible and powerful system (e.g. remote control of several tape recorders).

### 1.10.2 RS232 interface

---

The term "RS 232" defines a connection between a terminal and a modem. This standard also defines the:

- Electrical characteristics (levels, lines)
- Mechanical characteristics (connectors)
- Signal shapes and
- Standard connections.

This interface supports data transmission speeds up to 19.2 kbaud (for A827 MCH: 9.6 kbaud) and cable lengths up to 15 m.

The signal levels are defined as follows:

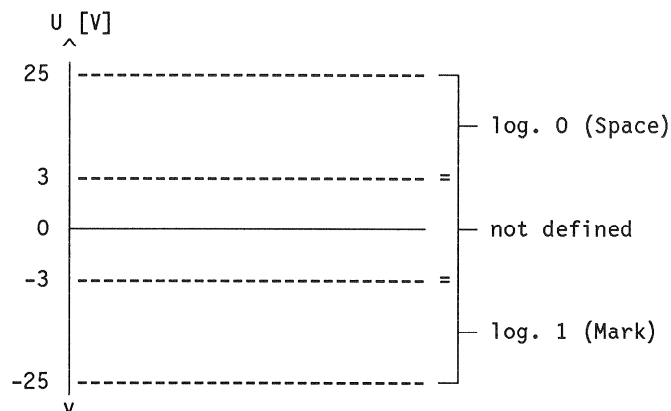

With a 25-pin connector different interface structures are feasible. In practice, however, only rarely are all 25 pins used. For establishing a terminal-terminal connection, modern systems are frequently based on the minimal structure defined in Section 2.8.1. All extensions (e.g. baud rate, code, synchronous/asynchronous connection, number of start/stop bits, hardware/software handshake) are defined by the manufacturer.

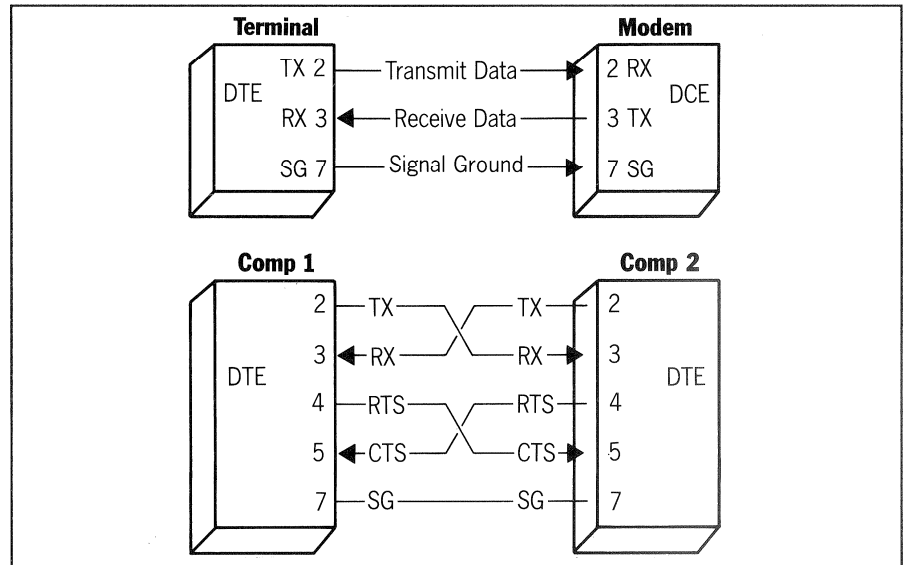

Fig. 1.10.2

### 1.10.3 Serial ASCII interface of the A827 MCH 1.810.751

For the serial interface of the A827 MCH tape recorder a 9-pin connector conforming to the SMPTE standard is used in place of the 25-pin connector. With the aid of an adapter cable the user can define whether the connected equipment functions as a terminal or as a modem.

Tape recorder 9-pin		Terminal 25-pin		Modem 25-pin	
Signal	Pin No.	Signal	Pin No.	Signal	Pin No.
SNDDATA	2	Trans.Data	2	Trans.Data	3
RCVDDATA	8	Rec.Data	3	Rec.Data	2
GROUND	9	Sig.Ground	7	Sig.Ground	7

No additional handshake lines are used. A software handshake (X ON/X OFF protocol) is used for all bit rates, but is only needed for 9.6 kbaud.

X ON = 0001 0001 (ASCII DC1) continue  
 X OFF = 0001 0011 (ASCII DC3) interrupt

After the reception of an X OFF signal the tape recorder still transmits up to two characters. After it has transmitted its own X OFF it can still receive up to five characters without losing a command.

- Basic setting:
- 1 start bit
  - 1 stop bit
  - 8 data bits
  - no parity
  - 9600 baud

The number of start and stop bits, even/odd parity and the following bit rates can be set in the ALIGNMENT DECK block of the software menu: 300, 1200 or 9600.

## 1.11 Storing the audio parameters

---

For increasing the reliability, all audio parameters can be copied from the audio microprocessor RAM to an external medium with the aid of the COMMUNICATION CONTROLLER 1.820.718.83. Subsequently the following terms are used:

- SAVE** For storing the RAM resident parameters on an external medium.  
**VERIFY** For comparing the externally stored data with the data in the tape recorder RAM.  
**LOAD** For loading the externally stored parameters into the tape recorder RAM.

On the A827 MCH there are two ways of saving data:

- Saving the data on the last audio channel of the own tape according to Section 1.11.1, in which case no cable is required.
- Saving the data on any channel of the own tape or on an external tape recorder according to Section 1.11.2, in which case a special prefabricated cable is needed.

### 1.11.1 Saving the data on the A827 MCH without cable

---

#### SAVE DATA

The audio parameters stored in the RAM are copied to the last audio channel. Depending on the headblock this is either channel 8, 16 or 24.

- Procedure:**
- Press the READY key of the last audio channel (8, 16 or 24) (green LED lights up).
  - Insert a sufficiently long piece of tape (recording duration at least 70 s).
  - Select the tape speed, preferably 15 or 30 ips.
  - Press RESET TIMER.
  - Start the machine in record mode.
  - Press SAVE on the COMMUNICATION CONTROLLER PCB 1.820.718. The LC display shows:

"DATA TRANSMISSION IN PROGRESS"  
PLEASE WAIT

The data are now written on tape. On completion of this process the LC display shows:

"DATA TRANSMISSION COMPLETED"

- Press the STORE key to clear the display.
- With the VERIFY procedure check that the data have been recorded correctly.

**VERIFY DATA**

The audio parameters stored on the last audio channel are compared with the RAM content on the audio microprocessor board.

- Procedure:**
- Select the same tape speed that has been used for the SAVE operation.
  - Insert the tape that contains the recorded parameters and rewind to the start of the recorded data.
  - Press the REPRO key of the last audio channel (depending on the headblock either channel 8, 16 or 24).
  - Press the VERIFY key on the COMMUNICATION CONTROLLER PCB 1.820.718.

The LC display shows:

"VERIFYING DATA"  
PLEASE WAIT

- Start the tape recorder in play mode.  
The data stored in RAM are now compared with the data read from tape. After this process has been completed, the LC display shows:

"VERIFICATION SUCCESSFULLY  
COMPLETED"

- Press the STORE key to clear the display.

**Note 1:** If transmission errors have occurred (e.g. caused by transient errors in the system voltage or contaminated heads), the following message is displayed:

ERROR  
VERIFY FAILED

- Press the STORE key to clear the display and repeat the process (clean the heads, if necessary).

**Note 2:** If after approx. 30 s the following information is displayed:

ERR: NO DATA FOUND  
ON TAPE

- Press the STORE key to clear the display.
- Check whether or not data have been recorded on tape (VU approx. -4dB) and rewind to the start of the data recording.
- Repeat the VERIFY process.

## DATA LOAD

The audio parameters stored on the last audio channel are written into the RAM on the audio microprocessor board.

- Procedure:**
- Select the same tape speed that has been used for recording the data with the SAVE function.
  - Insert the tape containing the recorded parameters and rewind to the start of the data recording.
  - Press the REPRO key of the last audio channel (8, 16 or 24).
  - Press the LOAD key on the COMMUNICATION CONTROLLER PCB 1.820.718.

The LC display shows:

"DATA LOADING IN PROGRESS"  
PLEASE WAIT

- Start the tape recorder in play mode.  
The data are now written from the tape into the RAM.  
On completion of the process the LC display shows:

"DATA LOADING COMPLETED"

- Press the STORE key to clear the display.
- With the VERIFY procedure check that the data have been correctly recorded on tape.

**Note:** If an error has occurred during data transmission (e.g. caused by transient errors in the operating voltage or contaminated heads), the following message is output:

ERROR  
NO DATA FOUND

- Press the STORE key to clear the display and repeat the process.
- With VERIFY check that the data have been correctly written into the RAM.



### 1.11.2 Data backup via cable on the A827 MCH or on an external tape recorder

#### SAVE DATA

The data stored in RAM can be copied via cable to any A827 MCH audio track or an external tape recorder.

- Procedure:**
- Connect one of the line inputs of a tape recorder to the 9-pin D-type connector (pin 7, ground pin 1) of the COMMUNICATION CONTROLLER PCB 1.820.718 (see Fig. 1.11.1).
  - Mount a sufficiently long piece of tape (recording duration at least 70 s).
  - Start the tape recorder in record mode on which the data are to be stored. Select the tape speed, preferably 15 or 30 ips.
  - Press SAVE on the COMMUNICATION CONTROLLER PCB 1.820.718. The LC display shows:

"DATA TRANSMISSION IN PROGRESS"  
PLEASE WAIT

The data are now written on tape. On completion of this process the LC display shows:

"DATA TRANSMISSION COMPLETED"

- Press the STORE key to clear the display.
- With the VERIFY procedure check that the data have been recorded correctly.

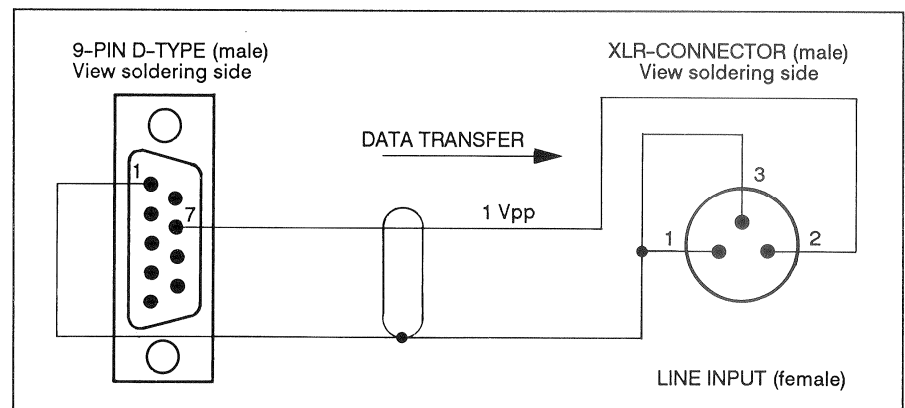

Fig. 1.11.1 Adapter cable for 1.820.718

## VERIFY DATA

The audio parameters stored on the last audio channel are compared with the RAM content on the audio microprocessor board.

- Procedure:**
- Connect the same line output that has been used for the SAVE operation to the 9-pin D-type connector (pin 3, ground pin 1) of the COMMUNICATION CONTROLLER PCB 1.820.718.
  - Select the same tape speed that has been used for the SAVE operation.
  - Insert the tape that contains the recorded parameters and rewind to the start of the recorded data.
  - Adjust the reproduce level: Turn the LEVEL potentiometer on the COMMUNICATION CONTROLLER 1.820.718 to the counterclockwise limit position and then open it clockwise until the LEVEL LED just lights up.
  - Rewind the tape with LOC START to the start of the recording and select VERIFY AND PLAY.

The LC display shows:

"VERIFYING DATA"  
PLEASE WAIT

The data stored in RAM are now compared with those read from tape. On completion of this process the LC display shows:

"VERIFICATION SUCCESSFULLY  
COMPLETED"

- Press the STORE key to clear the display.

**Note 1:** If transmission errors have occurred (e.g. caused by transient errors in the system voltage or contaminated heads), the following message is displayed:

ERROR  
VERIFY FAILED

- Press the STORE key to clear the display and repeat the process (clean the heads, if necessary).

**Note 2:** If after approx. 30 s the following information is displayed:

ERR: NO DATA FOUND  
ON TAPE

or if the yellow "LEVEL" LED above the 9-pin connector is not light even though data are present on the tape, the following adjustments should be performed:

- Adjust the reproduce level: Turn the LEVEL potentiometer on the COMMUNICATION CONTROLLER 1.820.718 to the counterclockwise limit position and then open it clockwise until the LEVEL LED just lights up.
- Press LOC START to rewind the tape to the start of the recording, then reselect VERIFY and PLAY.

**DATA LOAD**

The audio parameters are written into the RAM on the audio microprocessor board.

- Procedure:**
- Connect the same line output that has been used for the SAVE operation to the 9-pin D-type connector (pin 3, ground pin 1) of the COMMUNICATION CONTROLLER PCB 1.820.718.
  - Select the same tape speed that has been used for recording the data with the SAVE function.
  - Insert the tape containing the recorded parameters and rewind to the start of the data recording.
  - Press the REPRO key on the COMMUNICATION CONTROLLER PCB 1.820.718.
  - Start the tape recorder in play mode.

The LC display shows:

"DATA LOADING IN PROGRESS"  
PLEASE WAIT

The data are now written from the tape into the RAM.  
On completion of the process the LC display shows:

"DATA LOADING COMPLETED"

- Press the STORE key to clear the display.
- With the VERIFY procedure check that the data have been correctly stored in the RAM.

**Note:** If a transmission error has occurred, the following message is displayed:

ERROR  
NO DATA FOUND

- Possible causes:
  - Contaminated heads
  - Wrong tape speed
  - Incorrect level
- Press the STORE key to clear the display and repeat the last process.

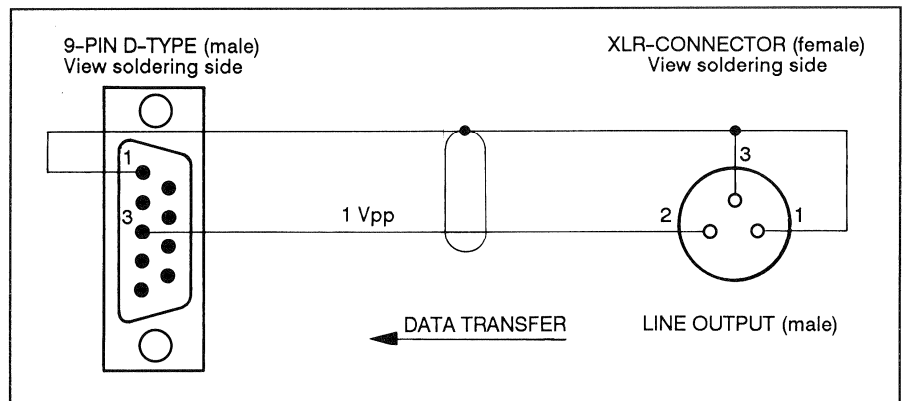
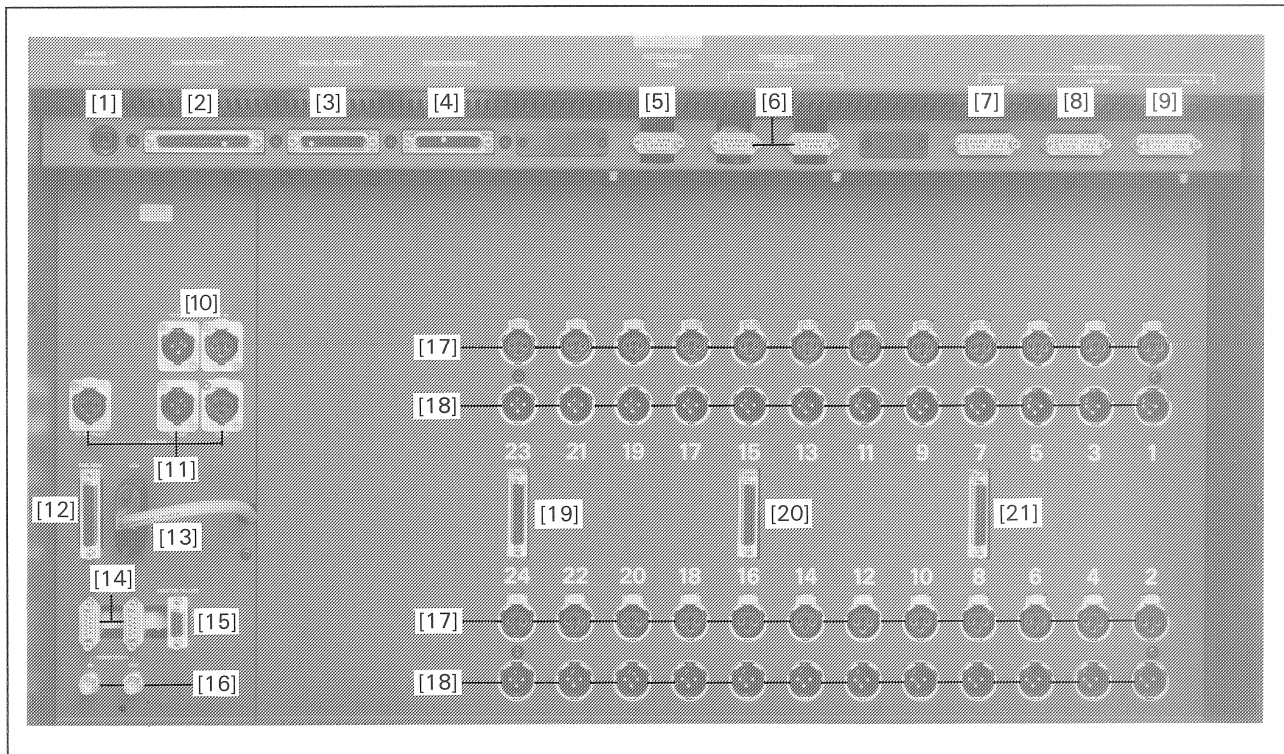

Fig. 1.11.2 Adapter cable for 1.820.718

## 2 Technical Information

### 2.1 Connections



- [1] Audio Parallel IF, refer section 2.1.2
- [2] Audio remote, refer section 2.1.2
- [3] Parallel remote, refer section 2.1.2
- [4] Synchronizer, refer section 2.1.2
- [5] Autolocator / Remote timer / Serial remote controller, refer section 2.1.2
- [6] Serial connector. The two connectors are parallel for SMPTE/EBU bus, RS 232 interface, refer section 2.1.2
- [7] NRS control channels 17 .. 24, refer section 2.1.2
- [8] NRS control channels 9 .. 16, refer section 2.1.2
- [9] NRS control channels 1 .. 8, refer section 2.1.2
- [10] Audio inputs, refer section 2.1.2
- [11] Audio outputs, refer section 2.1.2
- [12] Sync out 17..24, refer section 2.1.2
- [13] Sync out 9..16, refer section 2.1.2
- [14] Sync out 1..8, refer section 2.1.2
- [15] Master tallies, refer section 2.1.14
- [16] Composite video IN/OUT, refer section 2.1.15
- [17] Audio inputs, refer section 2.1.16
- [18] Audio outputs, refer section 2.1.17
- [19] Sync outputs 17...24, refer section 2.1.17
- [20] Sync outputs 9...16, refer section 2.1.17
- [21] Sync outputs 1...8, refer section 2.1.18

### 2.1.1 Mains Connection, Mains Voltage Selector

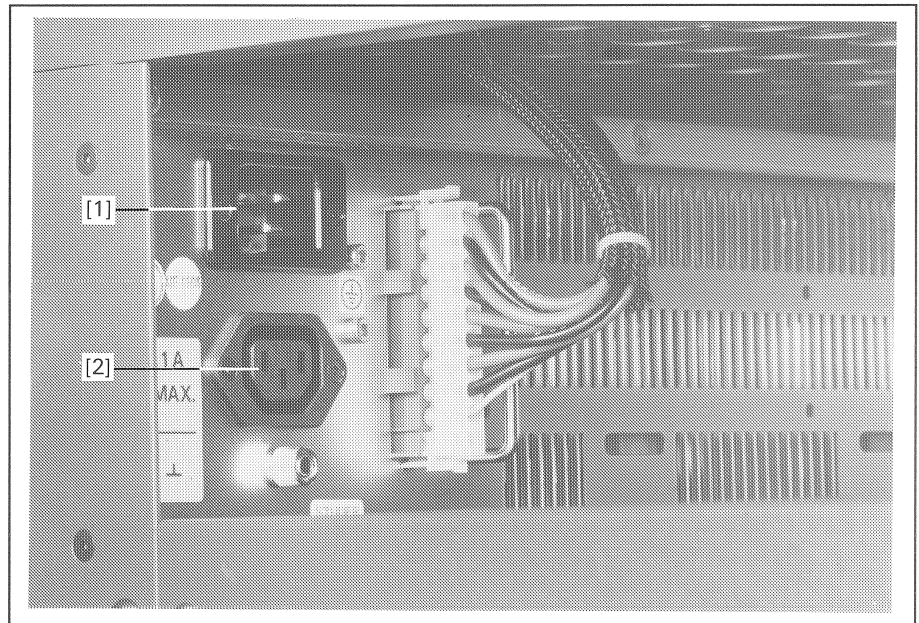

[1] Mains connector  
[2] Power connector for TLS 4000



Line voltage selector

**Caution** Before the recorder is connected for the first time, verify that the setting of the voltage selector on the front of the recorder matches the local mains voltage. The following mains voltages can be selected:  
100, 120, 140, 200, 220 and 240 VAC = 10%, 50–60Hz.

Disconnect the recorder from the AC supply before you change the voltage selector setting! Unfasten the cover of the voltage selector (3 screws [chromium plated], Allen key No. 2.5), and remove the switch setting mask (2 screws, Allen key No. 2.5) and position the switch setting mask that way that the desired voltage is visible on the front cover plate, possibly the switch setting mask must be rotated 180°. Fasten the switch setting mask and change over the five switches into the corresponding position. Fasten cover of the voltage selector.

### 2.1.2 Audio Parallel If

#### Parallel Channel Control Interface

A parallel remote control device of a mixing console can be connected via the PARALLEL CHANNEL CONTROL INTERFACE (Part. No. 21.328.500.00) to the AUDIO PARALLEL IF Connector of the A827 MCH tape recorder.

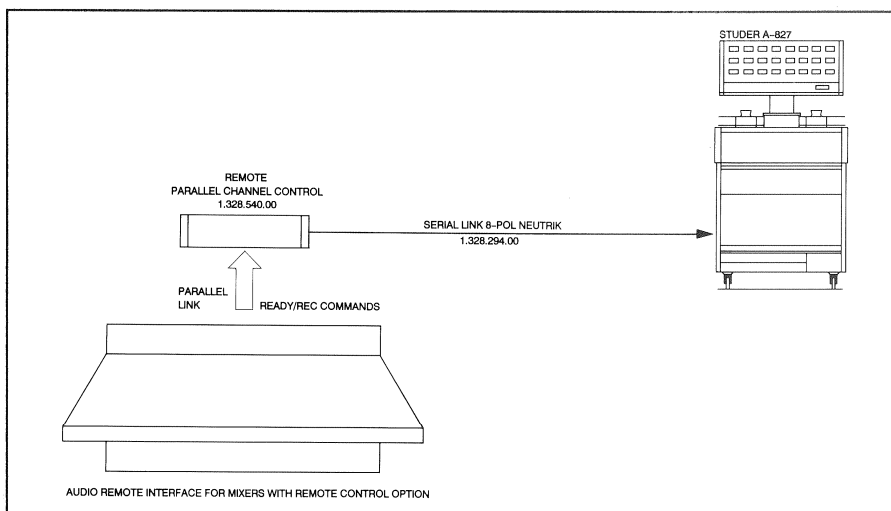

**Note:** The connection AUDIO PARALLEL IF is only active, if the key REM IF in the A827 is activated (the yellow LED lits).

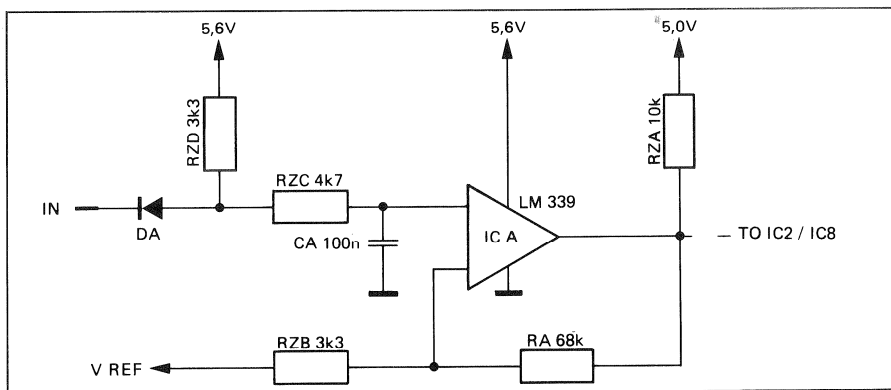

Input Circuit

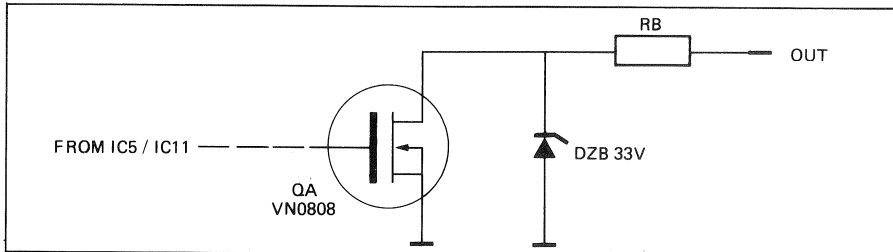

Output Circuit

**Pin assignment of the AUDIO PARALLEL IF connector**

Pin	Signal name	Color code	Designation
1	0STABIN	Shield	For channel remote
2	0STABIN	blue	For channel remote
3	0STABIN	violet	For channel remote
4	+STABIN4	red	Supply voltage for channel remote
5	+STABIN4	yellow	Supply voltage for channel remote
6	+STABIN4	brown	Supply voltage for channel remote
7	PNLBUS1	white	Serial remote cable
8	PNLBUS2	black	Serial remote cable

**Connector, complete:**

Neutrik, 8-pin, male

**Part No.**  
20.020.303.23

**Cable**

screened, 10 x 0.14 mm<sup>2</sup>

64.03.0149

If problems occur with cables longer than 50 m, a termination resistor may be connected between pins 7 and 8 at both cable ends. Typical rating (depending on cable resistance): 220 ohms ¼ W. Max. cable length 100 m.

**Pin Assignment of the PARALLEL REMOTE CHANNEL CONTROL connector:**

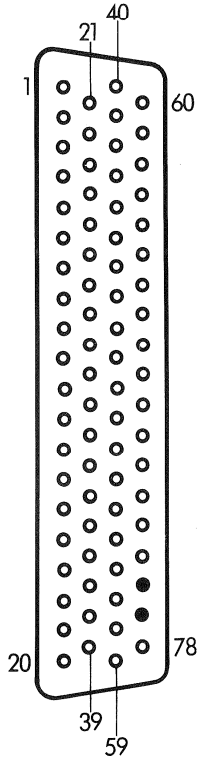

AUDIOCHANNELS 1...8			AUDIOCHANNELS 9...16			AUDIOCHANNELS 17..24		
Typ PIN	D, 78-pin SIG. NAME	Color/Remark	Typ PIN	D, 78-pin SIG. NAME	Color/Remark	Typ PIN	D, 78-pin SIG. NAME	Color/Remark
1	S-REA-01	brn	1	S-REA-09	brn	1	S-REA-17	brn
2	S-REA-02	red	2	S-REA-10	red	2	S-REA-18	red
3	S-REA-03	org	3	S-REA-11	org	3	S-REA-19	org
4	S-REA-04	red	4	S-REA-12	red	4	S-REA-20	red
5	S-REA-05	grn	5	S-REA-13	grn	5	S-REA-21	grn
6	S-REA-06	red	6	S-REA-14	red	6	S-REA-22	red
7	S-REA-07	blu	7	S-REA-15	blu	7	S-REA-23	blu
8	S-REA-08	red	8	S-REA-16	red	8	S-REA-24	red
25	B-REA-01	brn	25	B-REA-09	brn	25	B-REA-17	brn
26	B-REA-02	blk	26	B-REA-10	blk	26	B-REA-18	blk
27	B-REA-03	org	27	B-REA-11	org	27	B-REA-19	org
28	B-REA-04	blk	28	B-REA-12	blk	28	B-REA-20	blk
29	B-REA-05	grn	29	B-REA-13	grn	29	B-REA-21	grn
30	B-REA-06	blk	30	B-REA-14	blk	30	B-REA-22	blk
31	B-REA-07	blu	31	B-REA-15	blu	31	B-REA-23	blu
32	B-REA-08	blk	32	B-REA-16	blk	32	B-REA-24	blk
33	B-RCD-01	brn	33	B-RCD-09	brn	33	B-RCD-17	brn
34	B-RCD-02	red	34	B-RCD-10	red	34	B-RCD-18	red
35	B-RCD-03	org	35	B-RCD-11	org	35	B-RCD-19	org
36	B-RCD-04	red	36	B-RCD-12	red	36	B-RCD-20	red
37	B-RCD-05	grn	37	B-RCD-13	grn	37	B-RCD-21	grn
38	B-RCD-06	red	38	B-RCD-14	red	38	B-RCD-22	red
39	B-RCD-07	blu	39	B-RCD-15	blu	39	B-RCD-23	blu
40	B-RCD-08	red	40	B-RCD-16	red	40	B-RCD-24	red
53	0.0-DIG	org	53	0.0-DIG	blk	53	0.0-DIG	blk
54	+5.0-A	org	54	+5.0-B	org	54	+5.0-C	org
55	B-RES1		56	S-REMIN	blk	56	S-REMIN	blk
56	S-REMIN	blk						
57	B-RES2							
58	B-RES3							
59	B-INPM	rem. 1						
60	B-SYNM	rem. 2						
61	B-REPM	rem. 3						
62	B-REMENB	rem. 4						
63	B-M.SAFE	rem. 5						
64	B-RES4							
65	S-RES2							
66	S-RES3							
67	S-REMENB	rem. 6						
68	S-M.SAFE	rem. 7						
69	S-RES1							
71	S-REPM	rem. 8						
72	S-RES4	or						
73	S-INPM	rem. 9						
76	KEY		76	KEY		76	KEY	
77	KEY		77	KEY		77	KEY	

**Remarks:**

1. ON if switch S-INPM closed
2. ON if switch S-REPM not closed
3. ON if switch S-REPM closed
4. ON if parallel inputs active
5. ON if switch S-M.SAFE closed
6. Pulse input (flip-flop) interlocked with tape transport key (if available)
7. When this switch is closed, READY can no longer be selected or the READY function can no longer be activated (conductor color:red).
8. Switch open: M-SYNC, switch closed: M-REP (conductor color: brown: brown).
9. If switch closed: input with highest priority.



### 2.1.3 Audio Remote

**Audio Remote Connector:** An Audio Remote Modul can be interfaced via the the AUDIO REMOTE Connector (D-typ, 37 pole).

	<b>Order No.</b>
For 8 channel machine	21.328.523.81
For 16- and 24 channel machine	21.328.521.00)
Connector compl.	20.020.303.32
Connector case	54.13.7044
Connector 37 pole, pin 24 coded	10.217.001.10

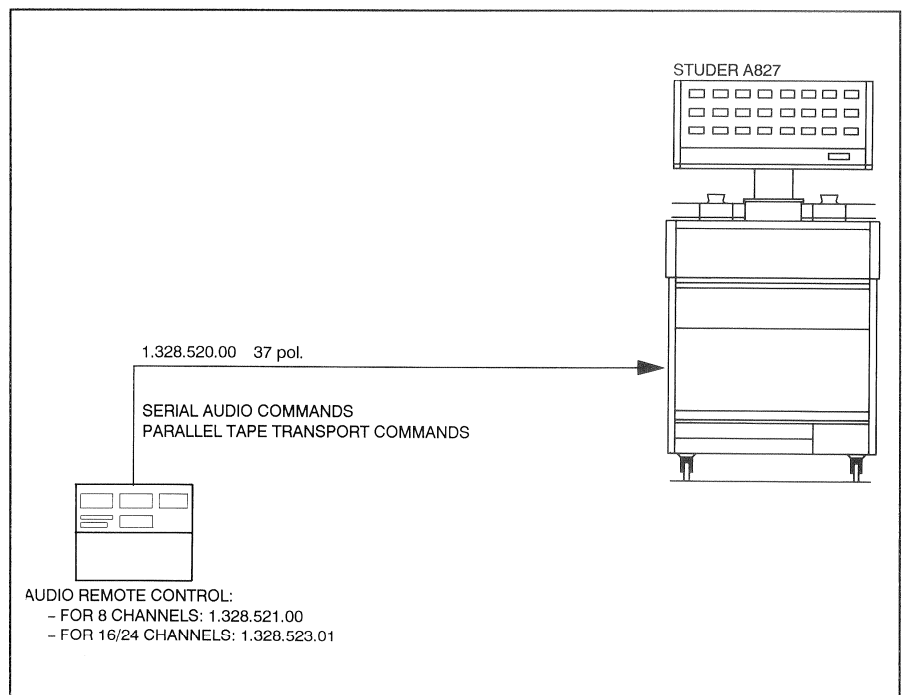

Pin assignment of the AUDIO REMOTE connector:

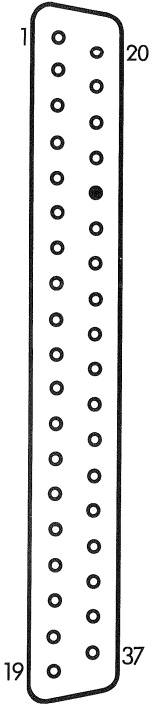

Pin	Signal name	Designation
01	+0.0	0V Ground
2	BR-REW*	Pilot lamp, REWIND
03	BR-FORW*	Pilot lamp, FORWARD
04	BR-VRSPD*	Pilot lamp, VARISPEED (alternatingly HIGH and LOW when active)
05	SR-VRSPD	Switch for VARISPEED command
06	SR-FADRY <sup>+</sup>	Switch for FADER START READY command
07	BR-LOCST*	Pilot lamp, LOC START
08	BR-FADRY*	Pilot lamp, FADER START READY
09	BR-REC*	Pilot lamp, RECORD
10	SR-RESET <sup>+</sup>	Switch for RESET TIMER command
11	FAD1	Input FADER START command, line A
12	FAD2	Input FADER START command, line B (FADER START active if 5..24 VAC or DC are present between 11 and 12)
13	IR-REFAR	Input for external capstan PLL reference (nominal 9.6 kHz, TTL-level recommended; max. input voltage = +12 V)
14	SR-0LOC <sup>+</sup>	Switch for ZERO LOC command
15	BR-PLAY*	Pilot lamp, PLAY
16	BR-STOP*	Pilot lamp, STOP
17	SR-LIFT <sup>+</sup>	Switch for LIFTER Befehl
18	SR-LOCST <sup>+</sup>	Switch for LOC START command
19	SR-REC <sup>+</sup>	Switch for RECORD command
20	SR-REW <sup>+</sup>	Switch for REWIND command
21	SR-FORW <sup>+</sup>	Switch for FORWARD command
22	SR-PLAY <sup>+</sup>	Switch for PLAY command
23	SR-STOP <sup>+</sup>	Switch for STOP command
24	KEY	Coding
25	+24.0 REM	+24 V supply (max. 300 mA)
26	PNL BUS 1	Audio Remote Control line A serial
27	PNL BUS 2	Audio Remote Control line B serial
28	+ STAB IN 4	Supply for Audio Remote Control
29	+ STAB IN 4	"
30	+ STAB IN 4	"
31	+ STAB IN 4	"
32	+ STAB IN 4	"
33	0 STAB IN	0V for Audio Remote Control
34	0 STAB IN	"
35	0 STAB IN	"
36	0 STAB IN	"
37	0 STAB IN	"

\* Open collector output active LOW. No internal pull-up resistor, max. HIGH level = +30 V. Max. load current 200 mA, internal current limiting resistor 22 ohm.

+ Switch input, LOW level activates the command. Internal pull-up resistor 4.7 kohm connected to +24 V supply, max. HIGH input level = +30 V, logic level: LOW = 0..+4 V, HIGH = +7.5..+30 V.

- Notes:**
- Audio functions are serial controlled.
  - Tape Deck functions are parallel controlled.
  - Only **activ**, if the **key REM IF on the A827 is not activated** (yellow LED doesn't lit).

2.1.4 Paralle Remote

Parallel remote control connector

A parallel remote control unit with the following features can be interfaced via this 25-pin connector (female, D-type):

- Remote control of the tape deck functions with feedback ( , , PLAY, STOP, and REC)
- RESET TIMER (resets the tape timer)
- ZERO LOC (automatically searches the tape timer address 0.00.00)
- LOC START (automatically searches the tape timer address at which the last PLAY command was entered)
- LIFTER (cancels the tape lifter during spooling for as long as this key is pressed)
- FADER (enables the fader start circuit)
- VARISPEED (variable tape speed)

Pin assignment of the PARALLEL REMOTE CONTROL connector:

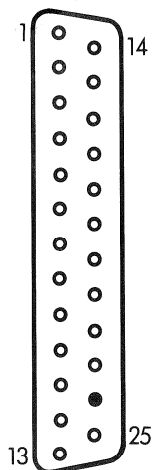

Pin	Signal name	Designation
01	+0.0	0V Ground
02	BR-REW *	Pilot lamp, REWIND
03	BR-FORW *	Pilot lamp, FORWARD
04	BR-VRSPD *	Pilot lamp, VARISPEED (alternatingly HIGH and LOW when active)
05	SR-VSPR +	Switch for VARISPEED command
06	SR-FADRY +	Switch for FADER START READY command
07	BR-LOCST *	Pilot lamp, LOC START
08	BR-FADRY *	Pilot lamp, FADER START READY
09	BR-REC *	Pilot lamp, RECORD
10	SR-RESET +	Switch for RESET TIMER command
11	FAD1	Input FADER START command, line A
12	FAD2	Input FADER START command, line B (FADER START active if 5.24 VAC or DC are present between pins 11 and 12).
13	IR-REFPR	Input for external capstan PLL reference (nominal 9,6 kHz, TTL level recommended; maximum input voltage +12 V)
14	SR-0LOC +	Switch for ZERO LOC command
15	BR-PLAY *	Pilot lamp, PLAY
16	BR-STOP *	Pilot lamp, STOP
17	SR-LIFT +	Switch for LIFTER command
18	SR-LOCST +	Switch for LOC START command
19	SR-REC +	Switch for RECORD command
20	SR-REW +	Switch for REWIND command
21	SR-FORW +	Switch for FORWARD command
22	SR-PLAY +	Switch for PLAY command
23	SR-STOP +	Switch for STOP command
24	KEY	Coding
25	+24.0 REM	+24 V supply (max. 300 mA)

\* Open collector output active LOW. No internal pull-up resistor, max. HIGH level = +30 V. Max. load current 200 mA, internal current limiting resistor 22 ohm.

+ Switch input, LOW level activates the command. Internal pull-up resistor 4.7 kohm connected to +24 V supply, max. HIGH input level = +30 V, logic level: LOW = 0..+4 V, HIGH = +7.5..+30 V.

Connector complete	Part No. 20.020.303.16
Connector housing, 25-pin	54.13.7022
Connector, 25-pin, coded	10.217.001.06

Configuration examples

Remote control circuit

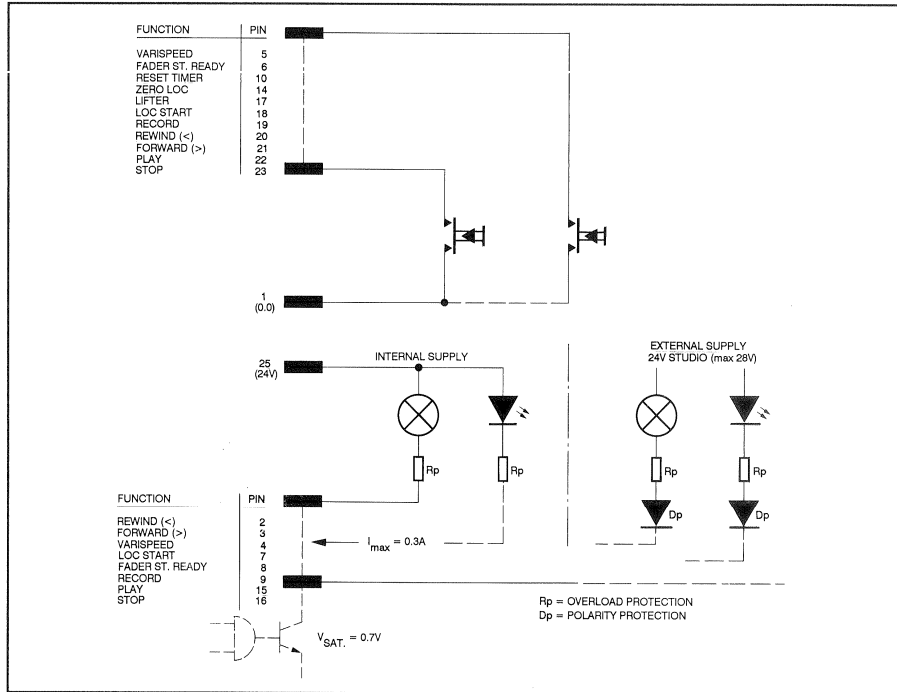

Varispeed circuit

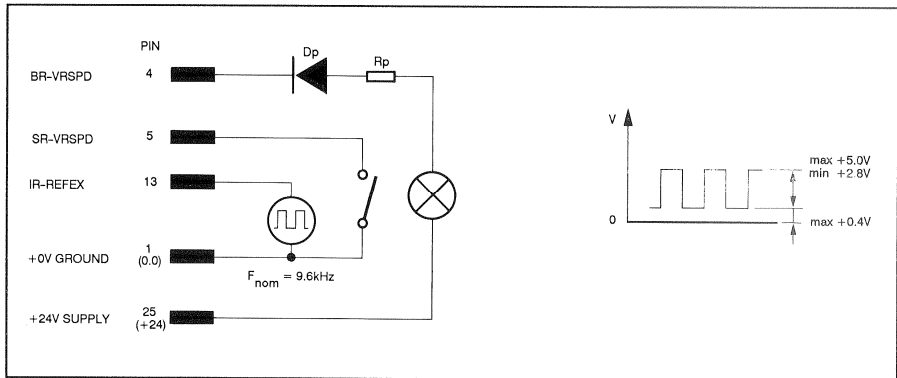

Fader start circuit

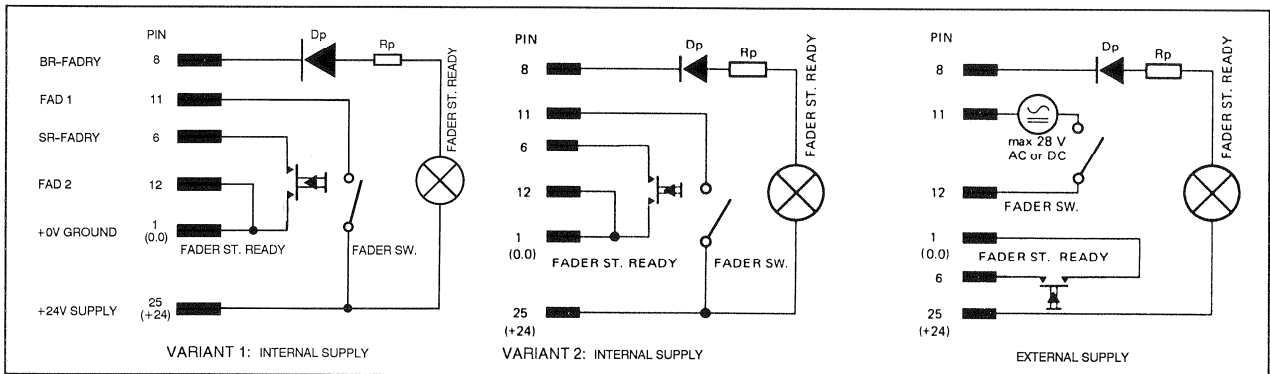

**Caution!** If filament light bulbs are used as pilot lamps, their inrush current should not exceed 0.3 A.

## 2.1.5 External synchronizer connector

An external synchronizer with the following facilities can be connected to this 25-pin connector (female, D-type):

Pin assignment of the EXTERNAL SYNCHRONIZER connector:

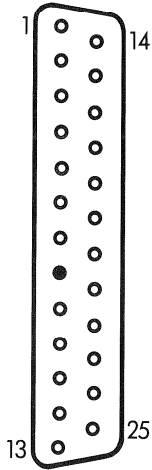

Pin	Signal name	Designation
01	+0.0	0V Ground
02	BR-REW *	Pilot lamp, REWIND
03	BR-FORW *	Pilot lamp, FORWARD
04	BR-VRSPD *	Pilot lamp, VARISPEED (alternatingly HIGH and LOW when active).
05	SR-VSSY +	Switch for VARISPEED command from Synchronizer
06	SR-REHSL +	Switch for REHEARSAL command
07	OR-MVCLK *	Output for TAPE MOVE CLOCK signal (512 pulses/15ich, pulse duty factor 50%)
08	KEY	Coding
09	BR-REC *	Pilot lamp RECORD
10	OR-MVDIR *	Output for TAPE MOVE DIRECTION signal (rewind = LOW, forward = HIGH)
11	OR-CMCLK *	Output for CAPSTAN MOTOR MOVE CLOCK signal (1200 impulses/sec at 7.5 ips)
12	OR-SYENB	Output for SYNCHRONIZER ENABLE signal (LOW = if tape is threaded and recorder ready, HIGH = when tape not tensioned)
13	IR-REF	Input for external capstan PLL reference from Synchronizer (nominal 9.6 kHz, TTL level recommended; max. input voltage = +30V)
14	+0.0	0V Ground
15	BR-PLAY *	Pilot lamp, PLAY
16	BR-STOP *	Pilot lamp, STOP
17	SR-LIFT +	Switch for LIFTER command
18	SR-MUTE +	Switch for MUTE Befehl (no influence on TC channel)
19	SR-REC +	Switch for RECORD command
20	SR-REW +	Switch for REWIND command
21	SR-FORW +	Switch for FORWARD command
22	SR-PLAY +	Switch for PLAY command
23	SR-STOP +	Switch for STOP command
24	SR-REVPS	Switch for REVERSE PLAY command
25	+24.0 REM	+24 V supply (max. 300 mA)

- \* Open collector output active LOW. No internal pull-up resistor, max. HIGH level = +30 V. Max. load current 200 mA, internal current limiting resistor 22 ohm.
- + Switch input, LOW level activates the command. Internal pull-up resistor 4.7 kohm connected to +24 V supply, max. HIGH input level = +30 V, logic level: LOW = 0..+4 V, HIGH = +7.5..+30 V.

Connector complete  
 Connector housing, 25-pin  
 Connector, 25-pin, coded

Part No.  
 20.020.303.15  
 54.13.7022  
 10.217.001.05

2.1.6 Autolocator/Timer

A serial remote control, a remote counter, or an autolocator can be connected via this 9-pin connector (female, solderable, D-type).

The keys of the serial remote control can be programmed by the user as desired. All functions available on the local keyboard can also be executed from the remote control. The functions available in the software tree can also be executed from the remote control. The functions programmed for the serial remote control do not necessarily have to be the same as those of the local keyboard.

Pin assignment of the AUTOLOCATOR/TIMER connector:

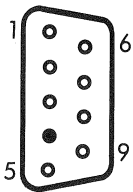

Pin	Signal name	Designation
01	SHIELD	Shield
02	SR-REC +	Switch for RECORD command
03	TR-A	Serial data line A
04	KEY	Coding
05	+0.0	0V
06	SR-PLAY +	Switch for PLAY command
07	TR-B	Serial data line
08	SIGN.GND	Signal ground
09	+STABIN4	Voltage supply

+ Switch Input, LOW level activates the command. Internal pull up resistor 4,7 kΩ with +24V voltage supply connected; max. HIGH input level = +30V, logic level: LOW=0...+4V, HIGH= +7,5...+30V.

Connector complete:

D-type, 9-pin, male, solderable, for cable end at the machine  
 D-type, 9-pin, female, solderable, for remote cable end  
 Cable: screened, 10 x 0.14 mm<sup>2</sup>

**Order no.:**  
 20.020.303.20  
 20.020.303.21  
 10.330.007.00

**2.1.7 RS232C port (ASCII coded) 1.810.751  
SMPTE/EBU port RS422/RS232C (binary coded) 1.820.751**

The following can be connected to this 9-pin (female, D-type) connector:

- A terminal with RS232C interface (ASCII protocol) or a TLS 4000 (via the serial remote controller 1.810.751, option 20.820.393.00)
- or
- A terminal with RS232C interface (binary protocol) or the SMPTE/EBU bus (RS422) via the SMPTE/EBU interface 1.820.751, (option 20.820.394.00).

**Option 1.810.751**

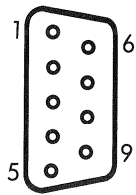

RS232 (ASCII-Protocol)	
Pin	Signal name
01	---
02	TX Transmit Data
03	---
04	---
05	---
06	---
07	---
08	RX Receive Data
09	0V Ground

- Normal RS232 use with \*NRZ form and ASCII Protocol

RS 232 (ASCII-Protocol)	
Pin	Signal name
01	0V Ground
02	---
03	---
04	RX Receive Data
05	---
06	TX Transmit Data
07	---
08	---
09	---

- normal RS232 use with \*biphase form and ASCII Protocol

**Option 1.820.751**

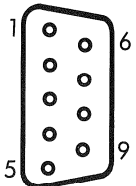

RS422 (SMPTE/EBU-Protocol)	
Pin	Signal name
01	Shield
02	Transmit A
03	Receive B
04	Receive Common
05	---
06	Transmit Common
07	Transmit B
08	Receive A
09	Shield

- SMPTE/EBU-use with \*NRZ-form

RS 232 (SMPTE/EBU Protocol)	
Pin	Signal name
01	SHIELD
02	---
03	RX Receive Data
04	0V Ground
05	---
06	0V Ground .....
07	TX Transmit Data
08	---
09	Shield

- SMPTE/EBU-use with \*NRZ-form

Communication Controller  
Print 1.820.718.XX

■ Anschlussbelegung der Communication Controller Buchse.

(9-polig, Typ D)

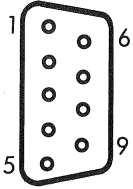

RS232 (ASCII-Protocol)	
Pin	Signalname
01	0V Ground
02	TX Transmit Data
03	---
04	---
05	---
06	---
07	---
08	RX Receive Data
09	---

- data backup on a PC  
in \*NRZ-form.

RS 232 (ASCII-Protocol)	
Pin	Signalname
01	0V Ground
02	---
03	Receive Data
04	---
05	---
06	---
07	Send Data
08	---
09	---

- data backup on tape in \*biphase-  
form.

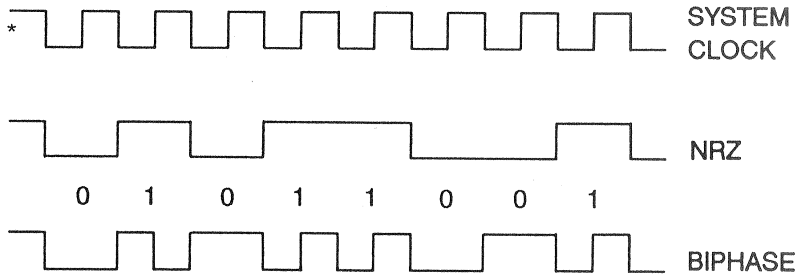

2.1.8 Noise Reduction System

Noise reduction system can be interfaced via the control connectors of the noise reduction system (one connector for eight channels). The encode/decode changeover is controlled via these connectors. The control characteristic is for dolby or telcom nrs-system selectable.

Pin assignment of the NRS  
CONTROL connector:

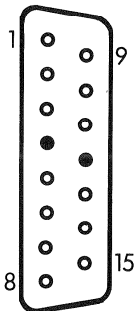

CHANNELS 1...8			CHANNELS 9...16			CHANNELS 17...24		
D type 15-pin PIN	SIG. NAME	COLOR	D type 15-pin PIN	SIG. NAME	COLOR	D type 15-pin PIN	SIG. NAME	COLOR
1	B-RCD-01	brn	1	B-RCD-09	brn	1	B-RCD-17	brn
2	B-RCD-02	red	2	B-RCD-10	red	2	B-RCD-18	red
3	B-RCD-03	org	3	B-RCD-11	org	3	B-RCD-19	org
4	KEY		4	KEY		4	KEY	
5	B-RCD-04	red	5	B-RCD-12	red	5	B-RCD-20	red
6	B-RCD-05	grn	6	B-RCD-13	grn	6	B-RCD-21	grn
7			7			7		
8			8			8		
9			9			9		
10	B-RCD-06	red	10	B-RCD-14	red	10	B-RCD-22	red
11	B-RCD-07	blu	11	B-RCD-15	blu	11	B-RCD-23	blu
12	KEY		12	KEY		12	KEY	
13	B-RCD-08	red	13	B-RCD-16	red	13	B-RCD-24	red
14	+24.0	brn	14	+24.0	brn	14	+24.0	brn
15	0.0-DIG-A	blk	15	0.0-DIG-B	blk	15	0.0-DIG-C	blk

Connector, complete:

D type, 15-pin, male, screw on

Order No.  
20.020.303.08



## 2.1.9 Time Code Slave IN/OUT

## SLAVE TC IN

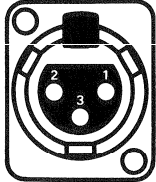

(3 pol. female XLR)

Pin	Signal Name	Function	Signal Type	Level
1	SHIELD	Shield		0 V
2	STC1 A	Slave TC "hot"	SMPTE TC	0.5 V <sub>pp</sub> to 10 V <sub>pp</sub>
3	STC1 B	Slave TC "cold"	SMPTE TC	

## SLAVE TC OUT

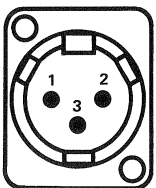

(3 pol. male XLR)

Pin	Signal Name	Function	Signal Type	Level
1	SHIELD	Shield		0 V
2	STC1 A	Slave TC "hot"	SMPTE TC	0.5 V <sub>pp</sub> to 10 V <sub>pp</sub>
3	STC1 B	Slave TC "cold"	SMPTE TC	

## 2.1.10 Time Code Master IN/OUT

## MASTER TC 1 IN

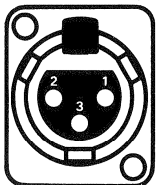

(3 pol. female XLR)

Pin	Signal Name	Function	Signal Type	Level
1	SHIELD	Shield		0 V
2	MTC2A	Master 2 TC "hot"	SMPTE TC	0.5 V <sub>pp</sub> to 10 V <sub>pp</sub>
3	MTC2B	Master 2 TC "cold"	SMPTE TC	

## MASTER TC OUT

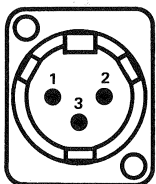

(3 pol. male XLR)

Pin	Signal Name	Function	Signal Type	Level
1	SHIELD	Shield		0 V
2	MTC1A	Master 1 TC "hot"	SMPTE TC	0.5 V <sub>pp</sub> to 10 V <sub>pp</sub>
3	MTC1B	Master 1 TC "cold"	SMPTE TC	

## MASTER TC IN/PILOT



(3 pol. female XLR)

Pin	Signal Name	Function	Signal Type	Level
1	SHIELD	Shield		0 V
2	MTC1A	Master 1 TC "hot"	SMPTE TC	0.5 V <sub>pp</sub> to 10 V <sub>pp</sub>
3	MTC1B	Master 1 TC "cold"	SMPTE TC	

2.1.11 Parallel remote (TLS-4000 MKI AUX Connector)

- Note:**
- The TLS-400 MK I parallel remote connector essentially has the same characteristics as the parallel remote connector [3] on the machine, see Section 2.1. However, the parallel remote connector of the TLS-4000 MK I should only be used in compelling situations.
  - If this connector is used, the external varispeed/capstan frequency (pin 13) must be interrupted, otherwise the capstan frequency controlled by the TLS-4000 will be adversely affected.

Pin assignment of the PARALLEL REMOTE CONTROL connector:

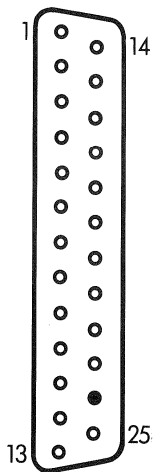

Pin	Signal name	Designation
01	+0.0	Ground
02	BR-REW *	Pilot lamp, REWIND
03	BR-FORW *	Pilot lamp, FORWARD
04	BR-VRSPD *	Pilot lamp, VARISPEED (alternatingly HIGH and LOW when active)
05	SR-VRSPD +	Switch for VARISPEED command
06	SR-FADRY +	Switch for FADER START READY command
07	BR-LOCST *	Pilot lamp, LOC START
08	BR-FADRY *	Pilot lamp, FADER START READY
09	BR-REC *	Pilot lamp, RECORD
10	SR-RESET +	Switch for RESET TIMER command
11	FAD1	Input FADER START command, line A
12	FAD2	Input FADER START command, line B (FADER START active if 5..24 VAC or DC are present between pins 11 and 12)
13	IR-REFEX	Input for external capstan PLL reference (nominal 9,6 kHz, TTL level recommended; maximum input voltage +12 V)
14	SR-0LOC +	Switch for ZERO LOC command
15	BR-PLAY *	Pilot lamp, PLAY
16	BR-STOP *	Pilot lamp, STOP
17	SR-LIFT +	Switch for LIFTER command
18	SR-LOCST +	Switch for LOC START command
19	SR-REC +	Switch for RECORD command
20	SR-REW +	Switch for REWIND command
21	SR-FORW +	Switch for FORWARD command
22	SR-PLAY +	Switch for PLAY command
23	SR-STOP +	Switch for STOP command
24	KEY	Coding
25	+24.0	+24 V supply (max. 300 mA)

- \* - Open collector output active LOW
  - No internal pull-up resistor
  - max. HIGH level = +30 V
  - Max. load current 200 mA
  - Internal current limiting resistor 22 ohm
- + - Switch input, LOW level activates the command
  - Internal pull-up resistor 4.7 kohm connected to +24 V supply
  - Max. HIGH input level = +30 V
  - Logic level: LOW = 0..+4 V, HIGH = +7.5..+30 V

Connector complete	<b>Part No.:</b> 20.020.303.16
Connector housing, 25-pin	54.13.7022
Connector, 25-pin, coded	10.217.001.06

2.1.12 LCU

LOCAL CONTROL UNIT

(15 pol. male D-Type)

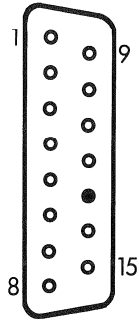

Pin	Signal Name	Function	Signal Type	Active		Level
				low	high	
1	+5.0 V	Supply	DC			5 V
2	+5.0 V	Supply	DC			5 V
3	+5.0 V	Supply	DC			5 V
4	0.0 V	Ground				0 V
5	0.0 V	Ground				0 V
6	0.0 V	Ground				0 V
7	LCU-Bus 2	Serial Data	Halfduplex			
8	0.0 V	Ground				0 V
9	+5.0 V	Supply	DC			5 V
10	+5.0 V	Supply	DC			5 V
11	+5.0 V	Supply	DC			5 V
12	S-ENABLE	LCU ENABLE	Switch In	x		TTL
13	KEY					
14	LCU-Bus 1	Serial Data	Halfduplex			
15	SHIELD	Shield				0 V

2.1.13 Serial Remote

SERIAL REMOTE/BUS

(9 pol. female D-Type)

■ RS 422:

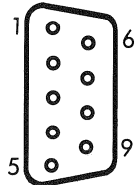

Pin	Signal Name	Function	Signal Type	Active		Level
				low	high	
1	SHIELD	Shield				0 V
2	TA	Transmit Data A	RS 422	x		
3	RB	Receive Data B	RS 422		x	
4	RC	Receive Common				0 V
5	N.C.					
6	TC	Transmit Common				0 V
7	TB	Transmit Data B	RS 422		x	
8	RA	Receive Data A	RS 422	x		
9	SHIELD	Shield				0 V

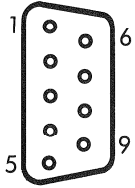

■ RS 232 C:

Pin	Signal Name	Function	Signal Type	Active		Level
				low	high	
1	SHIELD	Shield				0 V
2	N.C.					
3	RD	Receive Data	RS 232			
4	GND	Ground				0 V
5	N.C.					
6	GND	Ground	RS 232			0 V
7	TD	Transmit Data				
8	N.C.					
9	SHIELD	Shield				0 V

2.1.14 Master Tallies

MASTER TALLIES  
(TLS-4000 MKII)

(9 pol. female D-Type)

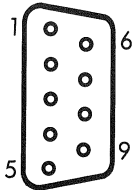

Pin	Signal Name	Function	Signal Type	Active		Level
				low	high	
1	0.0 V	Ground				0 V
2	M-STOP	STOP Message	Switch In	x		TTL
3	M-MOVE1	Master Ref 1	Switch In	x		TTL
4	M-PLAY	PLAY Message	Switch In	x		TTL
5	0.0 V	Ground				0 V
6	M-FREC	Follow Rec Cmd	Switch In	x		TTL
7	M-TPILOT	Master Pilot	20Hz..20kHz			
8	M-REC	REC Message	Switch In	x		TTL
9	M-MOVE2	Master Ref 2	Switch In	x		TTL

MASTER TALLIES  
(TLS-4000 MKI)

(9 pol. female D-Type)

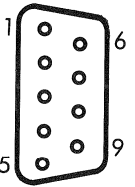

Pin	Signal Name	Function	Signal Type	Active		Level
				low	High	
1	0.0 V	Ground				0 V
2	BIPHASE1	MASTER Reference1	Switch In	x		TTL
3	BIPHASE2	MASTER Reference2	Switch In	x		TTL
4	---	---				
5	---	---				
6	IM-STOP	STOP Message from Master	Switch In	x		TTL
7	IM-PLAY	PLAY Message from MASTER	Switch In	x		TTL
8	IM-REC	REC Message	Switch In	x		TTL
9	IM-FREC	FOLLOW RECORD Command	Switch In	x	TTL	

Switch In = Input, it can be switched with an open collector or with a switch connected to ground or with TTL output.

### 2.1.15 Composite Video IN/OUT

COMP.VIDEO IN/OUT

(2x BNC)



Pin	Signal Name	Function	Signal Type	Level
Center	CVIDEO	Composite Video In/Out (looped through)		0.5 Vpp to 10 Vpp
Screen	0.0 V	Ground		0 V

### 2.1.16 Line Input and Output

The balanced inputs and outputs are provided on XLR male or female sockets (described in the IEC recommendation 268-14).

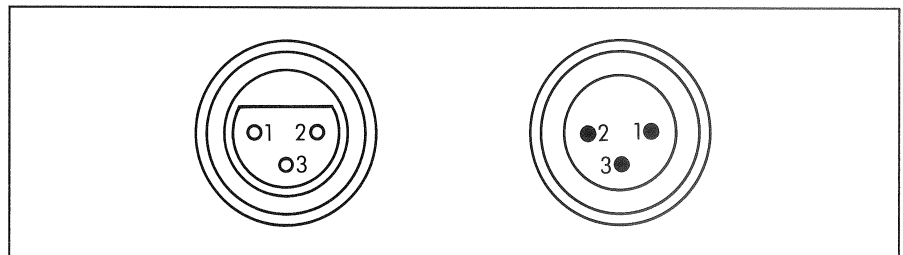

- 1 = Audio ground
- 2 = A-line
- 3 = B-line

In unbalanced circuits the a-line is the signal line and the b-line is connected to 0 Volt.

2.1.17 Sync Out (Asymmetrisch)

Pin assignment of the SYNC OUT D type connector 25 pin (female):

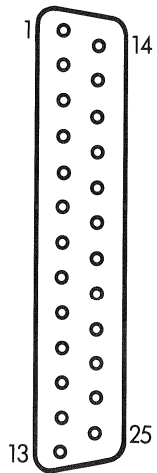

Pin	Signal name	Designation
01		
02		
03	O-SYNC-1	Signal GND CH1
04	O-SYNC-2	Signal GND CH2
05	O-SYNC-3	Signal GND CH3
06	O-SYNC-4	Signal GND CH4
07		
08	O-SYNC-5	Signal GND CH5
09	O-SYNC-6	Signal GND CH6
10	O-SYNC-7	Signal GND CH7
11	O-SYNC-8	Signal GND CH8
12		
13		
14		
15	A-SYNC-1	Signal CH1
16	A-SYNC-2	Signal CH2
17	A-SYNC-3	Signal CH3
18	A-SYNC-4	Signal CH4
19		
20		
21	A-SYNC-5	Signal CH5
22	A-SYNC-6	Signal CH6
23	A-SYNC-7	Signal CH7
24	A-SYNC-8	Signal CH8
25		

## 2.2 Jumper Array

### Serial Remote Controller 1.810.751.XX

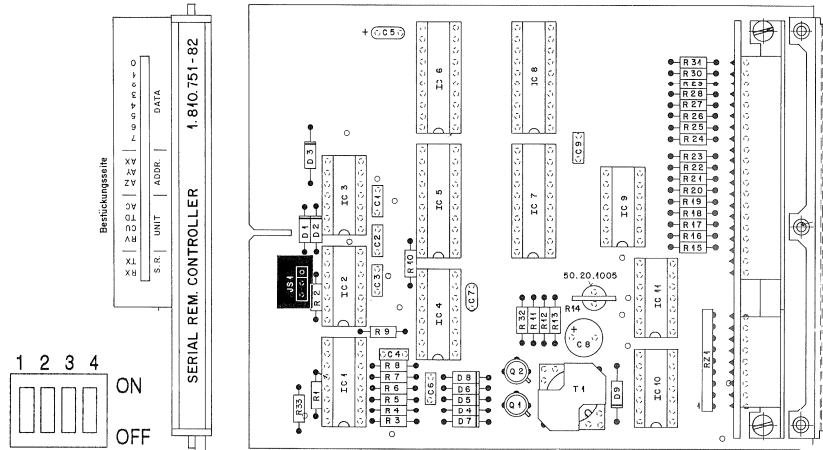

Standard setting:

DIP switches 1+3 of both rows in the "ON" position, all other DIP switches in the "OFF" position. DIP switch 1 activates the transmit (TX) and receive (RX) LED of the data control display.

### MP-Unit Audio Control 1.827.788.XX

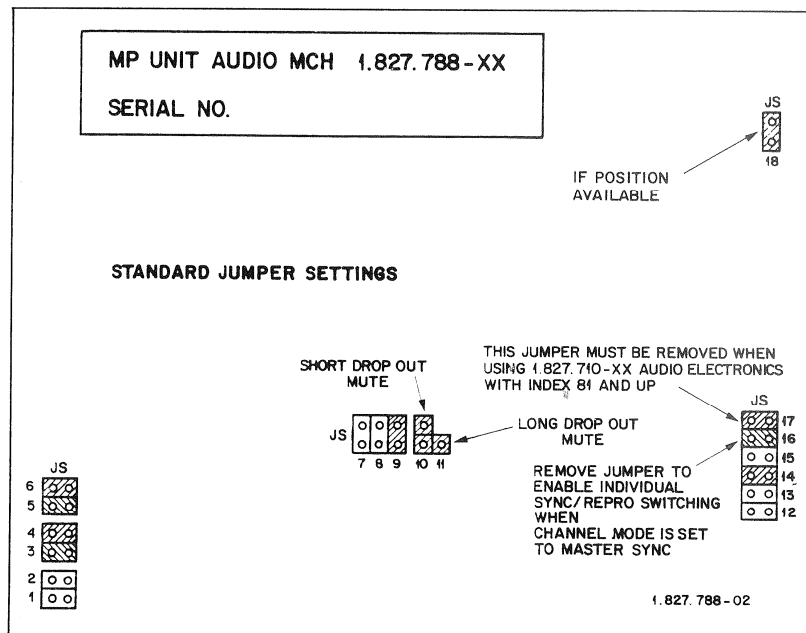

External NRS Controller  
1.820.816.XX

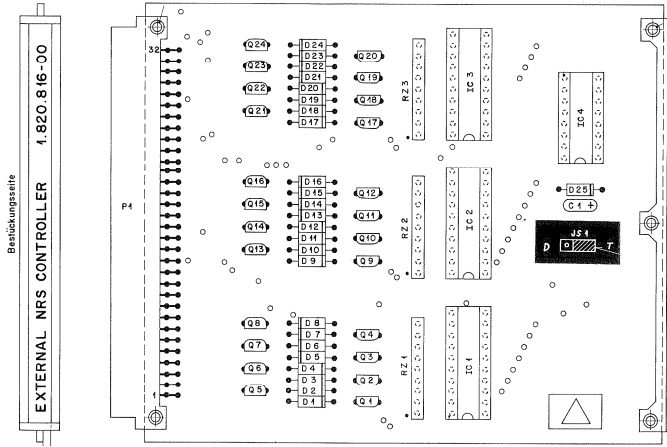

JS1 In pos. T: For TELCOM control  
In Pos. D: For Dolby control

In the menu tree also the function F054 Dolby/TELCOM must be set to the corresponding control.

Tape Deck Counter/Timer  
1.820.823.XX

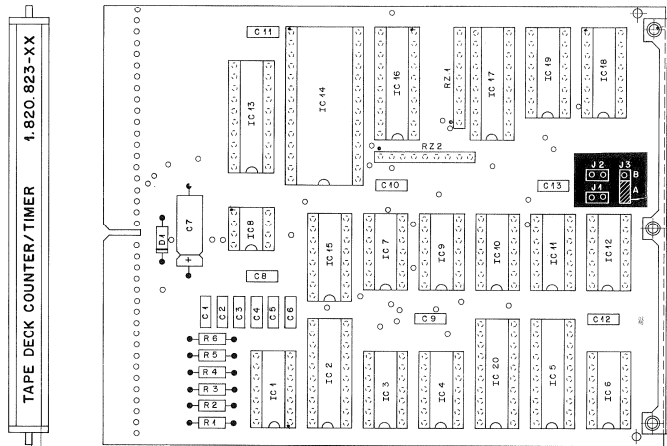

Jumpers J1-J3 determine the tape move clock available on the synchronizer connection (pin 7).

- J3 in pos. A = 1024 Hz at 30 ips
- J3 in pos. B and J1 inserted = 64 Hz at 30 ips
- J3 in pos. B and J3 inserted = 32 Hz at 30 ips



Audio Electronics Board  
1.827.710.xx

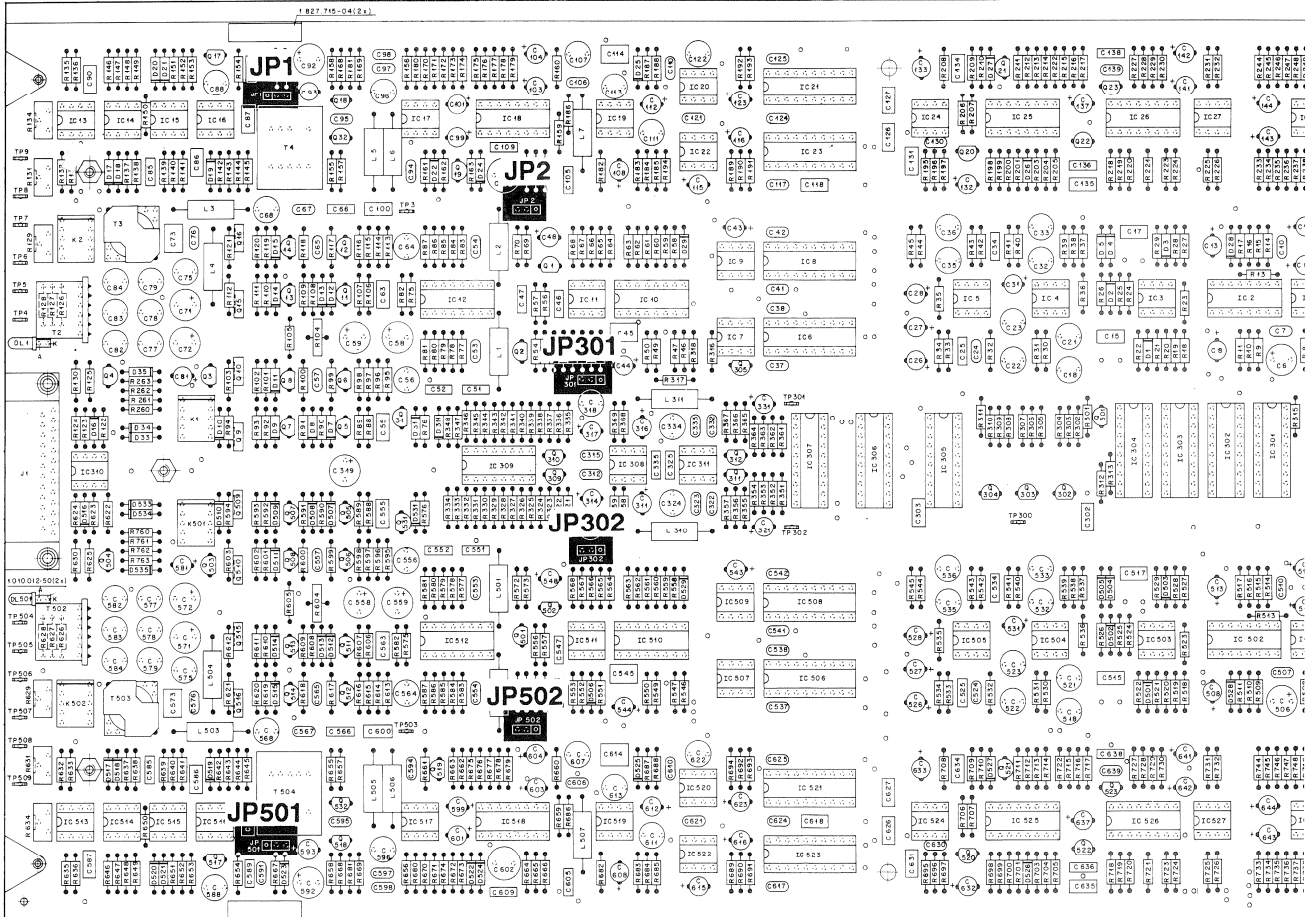

- |                                                                          |                                                                                                                                                                                                                                            |
|--------------------------------------------------------------------------|--------------------------------------------------------------------------------------------------------------------------------------------------------------------------------------------------------------------------------------------|
| <input type="checkbox"/> <input type="checkbox"/> JP1                    | The frequency response in SYNC mode is limited to 12 kHz on the odd channel.                                                                                                                                                               |
| <input type="checkbox"/> <input type="checkbox"/> JP501                  | The frequency response in SYNC mode is limited to 12 kHz on the even channel.                                                                                                                                                              |
| <input type="checkbox"/> <input checked="" type="checkbox"/> JP1         | The frequency response in SYNC mode is increased to the full frequency range, approx. 20 kHz on the odd channel. However, strong cross talk from the record channel into the SYNC reproduce channel can occur at frequencies above 12kHz.  |
| <input type="checkbox"/> <input type="checkbox"/> J501                   | The frequency response in SYNC mode is increased to the full frequency range, approx. 20 kHz on the even channel. However, strong cross talk from the record channel into the SYNC reproduce channel can occur at frequencies above 12kHz. |
| <input type="checkbox"/> <input checked="" type="checkbox"/> JP2/JP301   | SYNC signal on the SYNC OUTPUT on the odd channel.                                                                                                                                                                                         |
| <input type="checkbox"/> <input type="checkbox"/> JP502/JP302            | SYNC signal on the SYNC OUTPUT on the even channel.                                                                                                                                                                                        |
| <input checked="" type="checkbox"/> <input type="checkbox"/> JP2/JP301   | REPRO signal on the SYNC OUTPUT on the odd channel.                                                                                                                                                                                        |
| <input checked="" type="checkbox"/> <input type="checkbox"/> JP502/JP302 | REPRO signal on the SYNC OUTPUT on the even channel.                                                                                                                                                                                       |

## 2.3 Installation of the Serial ASCII Interface 1.810.751

- Set up the terminal as follows: 1 start bit, 8 data bits, 1 stop bit, no parity bit, baud rate 300, 1200 or 9600. No echo mode. Handshake lines CTS and RTS to LOW.

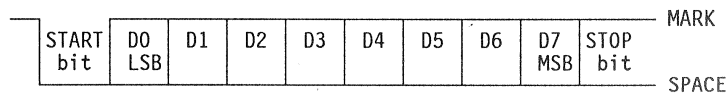

- SERIAL REMOTE CONTROLLER 1.810.751:** This board contains a receiver and a driver for the RS232 interface. This universal interface can also be switched over to balanced input and output for biphasic data transmission. This transmission mode is not required in the A827. For this reason the JS1 jumper on the serial interface 1.810.751.xx should be set to position H. Insert the PCB, activate the pilot LED by setting DIL switch 1 to "ON" When the A827 is switched on, the TX LED lights up briefly because the A827 transmits an identification code.
- Connect the computer or terminal via the adapter cable to one of the two 9-pin RS232 sockets on the rear of the A827 MCH. The two upper RX and TX LEDs on the serial interface 1.810.752.xx are light during the data flow between the A827 MCH and the terminal.
- Adjust the baud rate to the computer or terminal. After a RESET or after the A827 MCH has been switched OFF and ON, the following message appears on the terminal (only if: ECHO is ON in the alignment tape deck branch and the REMOTE key is ON):

```

A827 MCH MONITOR
ALL PROCESSES STARTED
    
```

The desired commands (see following command list) can now be entered via the terminal keyboard. The commands are executed as soon as the ENTER key (CR = Carriage Return) is pressed.

- Important:**
- Only upper case characters are accepted!
  - The REMOTE function (No. 345 or 346) has to be active!

### 2.3.1 Command Protocol Explanations

ASCII Protocol Specifications of RS232 Serial Interface for analog tape recorders STUDER A827 MCH

**Connector specifications**

- 9 pin connector, D type, (SMPTE/BUS / RS232 connector);
- pin out:

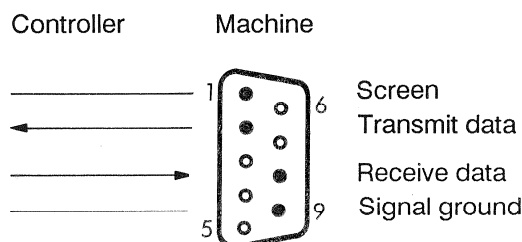

## Message Format

Expressions between single quotes represent a non printable ASCII character, e.g. 'CR' means carriage return.

The communication between the STUDER machine and the controller is implemented with ASCII coded strings of variable length.

A message string may contain of the following legal characters:

A...Z  
 0...9  
 ?, \_ (SPACE)  
 and the control characters:  
 'CR' (0Dh)  
 'LF' (0Ah)  
 'CX' (18h)  
 'XOFF' (13h)  
 'XON' (11h)

All command mnemonics have a length of 3 characters and are usually terminated by a 'CR'.

Only commands with parameters vary in length. The additional characters follow the command and are terminated by 'CR'. The parameters are separated by blanks or colons. There are some commands which do not have termination characters. Please refer to the individual command description for the exact syntax of each command.

The STUDER machine uses the sequence 'CR LF' as acknowledge message or termination.

**Example:**

**WNF\_0400 'CR'** = controlled wind forward at 4 times nominal speed

**WNF** = command, controlled wind forward

**0400** = parameter, 0400h coded as ASCII string

**The controller will send to the machine:**

character	ASCII code sent
W	57h
N	4Eh
F	46h
_	20h
0	30h
4	34h
0	30h
0	30h
'CR'	0Dh

The machine should  
answer:

'CR'	0Dh
'LF'	0Ah

The 'CX' control character is used by the controller to reset the STUDER machine's communication port.

'XOFF' and 'XON' are used as handshake characters:  
'XOFF': stop transmission  
'XON': resume transmission

For terminal operation, the machine's communication port can operate in 'echo mode'. In this mode, an echo of each character is sent back to the controller and a prompt (>) is sent after the answer string.  
The echo mode may be set via the machine's menu. It should not be used for computer remote control.

## Communication Protocol

---

### General informations

The communication between the controller and the STUDER machine is a master-slave protocol. The controller is the master and initiates the communication. The communication has to meet the following specifications:

- the machine has to acknowledge a command with a 'CR LF' within 100 msec from the moment that the command's last byte is received;
- the machine's communication port may be reset (both receiver and transmitter) by a 'CX' sent by the controller, and it has to acknowledge it with a 'CR LF' in the specified time;
- the machine can interrupt the controller anytime by sending an 'XOFF' and resume the communication sending an 'XON'. They do not have to be acknowledged by the controller;
- for the controller, there is no specification for the time between two bytes of a command;
- the controller should not output the next command before having received the machine's answer (exception: 'CX').

### Error messages

Not defined messages are acknowledged by: ? 'CR LF'

If the machine is in echo mode, it responds with (same with some older software revisions):

**INPUT FORMAT ERROR ! 'CR LF'**

- Notes:**
- After power on, the machine may announce itself with a welcome message
  - After a power on or an error message, it is recommended to initialize the communication by sending 'CX'. The communication is reestablished as soon as the machine answers with 'CR LF' within the specified time.
  - The machine is capable of handling at least 10 commands per second without XOFF-XON interference.
  - A locate command has a particular option. It can be followed by a command 'play' or 'record'. This preselection means that, once the locate is terminated, the machine will go in play or record. Preselection commands (play or record) can be repeated without cancelling the execution of the locate command.
  - After the reception of a DST or ST command, the machine answers with the continuously updated status.  
DST answers with the actual tape counter value, followed by the message "xx status achieved" (or "xx status not achieved").  
ST just punches out the HEX value corresponding to the status.
  - The DST-answer to a locate command is 'locate wind forward' or 'locate rewind', either 'achieved' or 'not achieved'. In addition, the machine may also answer 'play not achieved' or 'record not achieved', if play or record has been preselected.
  - A locate command is considered as completed when the machine sends a stop status.  
When the execution of 'locate' with a preselection of play or record is completed, the machine sends back the status 'play achieved' respectively 'record achieved'.
  - There are two exceptions with the A810 and A807 machines. The commands F and R are not followed by the acknowledgement 'CR LF'. That helps to increase the data transfer rate.

TAPE DECK COMMAND A827			Meaning
Sign Set	Input	Output	
STP	STP 'CR'	'CR LF'	Stop
EDI	EDI 'CR'	'CR LF'	Edit
PLY	PLY 'CR'	'CR LF'	Play
RPL	RPL 'CR'	'CR LF'	Reverse play
REC	REC 'CR'	'CR LF'	Record
FWD	FWD 'CR'	'CR LF'	Forward
RWD	RWD 'CR'	'CR LF'	Rewind
WNR	WNR_xxxx	'CR LF'	Control rewind speed xxxx = 0000 to 5FFFF 0000 = minimum wind speed 5FFF = maximum wind speed, depending on the selected max. wind speed
WNF	WNR_xxxx	'CR LF'	Control wind forward speed xxxx = 0000 to 5FFFF 0000 = minimum wind speed 5FFF = maximum wind speed, depending on the selected max. wind speed
SSA	SSA 'CR'	'CR LF'	Set play speed A (3.75 IPS)
SSB	SSB 'CR'	'CR LF'	Set play speed B (7.50 IPS)
SSC	SSC 'CR'	'CR LF'	Set play speed C (15 IPS)
SSD	SSD 'CR'	'CR LF'	Set play speed D (30 IPS)
SVP	SVP_xxxxxx 'CR'	'CR LF'	Set varispeed parameter xxxxxx = 00A5FE bis 018ACE 00A5FE = minimum (variable) tape speed (-7.5 semitones) 018ACE = maximum (variable) tape speed (+7.5 semitones) 010000 = nominal tape speed
NS?	NS? 'CR'	xx IPS 'CR LF' xx = 3.75, 7.5, 15, 30	Nominal speed ?
VS?	VS? 'CR'	xxxxxx 'CR LF'	Varispeed parameter? xxxxxx = 00A5FE bis 018ACE 00A5FE = minimum (variable) tape speed (-7.5 semitones) 018ACE = maximum (variable) tape speed (+7.5 semitones) 010000 = nominal tape speed
SVS	SVS 'CR'	'CR LF'	Varispeed on

TAPE DECK COMMAND A827			Edition: 21.12.1990
Sign Set	Input	Output	Meaning
CVS	CVS 'CR'	'CR LF'	Varispeed off
VEN	VEN 'CR'	'CR LF'	External varispeed on
VEF	VEF 'CR'	'CR LF'	External varispeed off
FEN	FEN 'CR'	'CR LF'	Fader enable on
FEF	FEF 'CR'	'CR LF'	Fader enable off
EDT	EDT 'CR'	'CR LF'	Lifter mode on, audio not muted, audio mode override, tape on heads Remark: corresponds lifter B, see F260
LFT	LFT 'CR'	'CR LF'	Lifter mode off (tape not on heads)
LFN	LFN 'CR'	'CR LF'	Lifter mode on, audio muted, audio mode not switched, tape on heads Remark: corresponds lifter A, see F260
LOC	LOC_hh:mm:ss:x'CR LF' oder LOC_-h:mm:ss:x		Locate to address hh = hours, -h = negative counter value mm = minutes ss = seconds x = tenths of seconds
LMV	LMV xxxxxxxx	'CR LF'	Locate to move puls xxxxxxx = 00000000 bis FFFFFFFF
ZLO	ZLO 'CR'	'CR LF'	Locate to zero
MV?	MV? 'CR'	xx_xx_xx_xx 'CR LF'	move puls counter?
STM	STM_hh:mm:ss:x oder STM_-h:mm:ss:x	'CR LF'	Set timer on address < > -9:59:59:999<ADDR<23:59:999
RTI	RTI 'CR'	'CR LF'	Reset timer
TM?	TM? 'CR'	hh:mm:ss:x 'CR LF' or -h:mm:ss:x or uh:mm:ss:x or oh:mm:ss:x	timer? -9:59:59<ADDR<23:59:59 hh = hours, mm = minutes, ss = seconds, x = tenths of seconds - = negative counter value u = counter value < -9:59:59:9 (underflow) o = counter value > 23:59:59:9 (overflow)

TAPE DECK COMMAND A827

Edition: 21.12.1990

Sign Set	Input	Output	Meaning
ST?	ST? 'CR'	xx 'CR LF' xx: 01 = tape out	<p>Status?</p> <p>81 = tape out achieved                      02 = stop                      82 = stop achieved                      03 = rewind                      83 = rewind achieved                      04 = forward                      84 = forward achieved                      05 = play                      85 = play achieved                      06 = play varispeed                      86 = play vari achieved                      07 = play internal ref                      87 = play int ref ach                      08 = play external ref                      88 = play ext ref ach                      09 = record or rehearse record                      89 = record ach or rehearse rec ach                      0A = reserved for (reh) record indic B                      8A = reserved for (reh) record indic B ach                      0B = edit                      8B = edit achieved                      0C = play fader                      8C = play fader achieved                      25 = reverse play                      A5 = reverse play ach.                      26 = reverse play vari                      A6 = rev play vari ach.                      27 = rev play int ref                      A7 = rev ply int ref ach                      28 = rev play ext ref                      A8 = rev ply ext ref ach                      29 = reverse rec or rehears reverse rec                      A9 = reverse record ach or reh rev rec ach                      2A = reserved for revers record indic B or reh rev rec ind B                      AA = reserved for rev rec indic B ach or reh rev rec ind B ach                      40 = shuttle backward                      C0 = shuttle backw ach</p>



TAPE DECK COMMAND A827			Edition: 21.12.1990
Sign Set	Input	Output	Meaning
			41 = shuttle forward C1 = shuttle forw ach 42 = locate rewind C2 = locate rewind ach 43 = locate forward C3 = locate forward ach 44 = locate play reverse C4 = loc play reverse ach 45 = locate play forw C5 = loc play forw ach 46 = cueing reverse C6 = cueing reverse ach 47 = cueing forward C7 = cueing forward ach 48 = position play rev C8 = position ply rv ach 49 = position play forw C9 = position ply fw ach 4A = rewind controlled CA = rewind contrl ach 4B = wind forw contrl CB = wind forw ctrl ach 59 = tape dump D9 = tape dump achieved 5A = cut DA = cut achieved DD = burn in achieved
DST	DST 'CR'	'CR LF' hh:mm:ss:x_nn_ttt	hh = hours, mm = minutes, ss = seconds, x = tenths of seconds - = negative counter value u = counter value < -9:59:59:9 (underflow) o = counter value > 23:59:59:9 (overflow) nn = status display code, e.g. 82 = stop achieved; refer to ST? ttt = Text, e.g. STOP ACHIEVED

TAPE DECK COMMAND A827

Edition: 21.12.1990

Sign set	Input	Output	Meaning
TP?	TP? 'CR'	aabbccddeeff_gghhijjkkll _mmnnooppqqrr 'CR LF'	tape tension parameter?  Tape tension for 1" tape <sup>17</sup> : aa: tape tension play left bb: tape tension play right cc: tape tension wind dd: tape tension edit ee: ttension rev play left ff: ttension rev play right Tape tension for 2" tape <sup>14</sup> : gg: tape tension play left hh: tape tension play right ii: tape tension wind jj: tape tension edit kk: ttension rev play left ll: ttension rev play right Tape tension for conversion 2" to 1" tape <sup>14</sup> : mm: tape tension play left nn: tape tension play right oo: tape tension wind pp: tape tension edit qq: ttension rev play left rr: ttension rev play right

<sup>17</sup> According to machine setting (Tape A or Tape B) the corresponding parameters are shown.

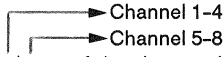
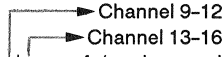
AUDIO COMMANDS A827 Enter via master RS232			Edition: 21.12.1990
Sign set	Input	Output	Meaning
SNB	SNB 'CR'	'CR LF'	Set NAB equalization
SCR	SCR 'CR'	'CR LF'	Set CCIR equalization
STA	STA 'CR'	'CR LF'	Set tape sort A
STB	STB 'CR'	'CR LF'	Set tape sort B
MSN	MSN 'CR'	'CR LF'	Master safe on
MSF	MSF 'CR'	'CR LF'	Master safe off
SRH	SRH 'CR'	'CR LF'	Rehearsal mode on only with drop in/out delay on, see F061
CRH	CRH 'CR'	'CR LF'	Rehearsal mode off
DDN	DDN 'CR'	'CR LF'	Drop in/out delay on
DDF	DDF 'CR'	'CR LF'	Drop in/out delay off
AA?	AA? 'CR'	aabbccdd *1  a   a = safe/ready record b   b = Tape/Input c   c = Rep/Sync d   d = Demute/mute aabbccdd 'CR LF' aa: 0 = safe 1 = ready/record bb: 0 = tape 1 = input cc: 0 = rep 1 = sync dd: 0 = demute 1 = mute	Channel 1-8 status? 1 = CH1   CH5 2 = CH2   CH6 3 = CH1+CH2   CH5+CH6 4 = CH3   CH7 5 = CH1+CH3   CH5+CH7 6 = CH2+CH3   CH6+CH7 7 = CH1+CH2+CH3   CH5+CH6+CH7 8 = CH4   CH8 9 = CH1+CH4   CH5+CH8 A = CH2+CH4   CH6+CH8 B = CH1+CH2+CH4   CH5+CH6+CH8 C = CH3+CH4   CH7+CH8 D = CH1+CH3+CH4   CH5+CH7+CH8 E = CH2+CH3+CH4   CH6+CH7+CH8 F = CH1+CH2+CH3+CH4   CH5+CH6+CH7+CH8
AB?	AB? 'CR'	aabbccdd *1  a   a = safe/ready record b   b = Tape/Input c   c = Rep/Sync d   d = Demute/mute aabbccdd 'CR LF' aa: 0 = safe 1 = ready/record bb: 0 = tape 1 = input cc: 0 = rep 1 = sync dd: 0 = demute 1 = mute	Channel 9-16 status? 1 = CH9   CH13 2 = CH10   CH14 3 = CH9+CH10   CH13+CH14 4 = CH11   CH15 5 = CH9+CH11   CH13+CH15 6 = CH10+CH11   CH14+CH15 7 = CH9+CH10+CH11   CH13+CH14+CH15 8 = CH12   CH16 9 = CH9+CH12   CH13+CH16 A = CH10+CH12   CH14+CH16 B = CH9+CH10+CH12   CH13+CH14+CH16 C = CH11+CH12   CH15+CH16 D = CH9+CH11+CH12   CH13+CH15+CH16 E = CH10+CH11+CH12   CH14+CH15+CH16 F = CH9+CH10+CH11+CH12   CH13+CH14+CH15+CH16

AUDIO COMMANDS A827			
Sign set	Input	Output	Meaning
AC?	AC? 'CH'	aabbccdd *1  a a = safe/ready record b b = Tape/Input c c = Rep/Sync d d = Demute/mute aabbccdd 'CR LF' aa: 0 = safe 1 = ready/record bb: 0 = tape 1 = input cc: 0 = rep 1 = sync dd: 0 = demute 1 = mute	Channel 17-24 status? 1 = CH17   CH21 2 = CH18   CH22 3 = CH17+CH18   CH21+CH22 4 = CH19   CH23 5 = CH17+CH19   CH21+CH23 6 = CH18+CH19   CH22+CH23 7 = CH17+CH18+CH19   CH21+CH22+CH23 8 = CH20   CH24 9 = CH17+CH20   CH21+CH24 A = CH18+CH20   CH22+CH24 B = CH17+CH18+CH20   CH21+CH22+CH24 C = CH19+CH20   CH23+CH24 D = CH17+CH19+CH20   CH21+CH23+CH24 E = CH18+CH19+CH20   CH22+CH23+CH24 F = CH17+CH18+CH19+CH20   CH21+CH22+CH23+CH24
REA <i>	REA_<i>_'CR' i=1..18H or FFH for all	'CR LF'	Set channel i to ready
SAF <i>	SAF_<i>_'CR' i=1..18H or 0FFH for all	'CR LF'	Set channel i to safe
INP <i>	INP_<i>'CR' i=1..18H or 0FFH for all	'CR LF'	Set channel i to input
SYN <i>	SYN_<i>'CR' i=1..18H or 0FFH for all	'CR LF'	Set channel i to synch
REP <i>	REP_<i>_'CR' i=1..18H or 0FFH for all	'CR LF'	Set channel i to repro
MTN <i>	MTN_<i>'CR' i=1..18H or 0FFH for all	'CR LF'	Mute channel i
MTF <i>	MTF_<i>'CR' i=1..18H or 0FFH for all	'CR LF'	Demute channel i
CHN <i>	CHN_<i>'CR] i=1..18H or 0FFH for all	'CR LF'	Channel i on
CHF <i>	CHF_<i>'CR] i=1..18H or 0FFH for all	'CR LF'	Channel i off

\*1 Exempel: Status request for Channel 1 to 8

AA? = 5 8 B 3 F 9 E 2 = a|a = 5|8 = Channel 1/3/8 ready record, all other on safe  
                           ↳ | = b|b = B|3 = Channel 1/2/4/5/6 in input mode  
                               ↳ | = c|c = F|9 = Channel 1/2/3/4/5/8 in Sync mode (Channel 6/7 in Repro mode)  
                                   ↳ = d|d = E|2 = channel 2/3/4/6 muted

MACHINE COMMANDS A827			Edition: 21.12.1990
Sign set	Input	Output	Meaning
LCD	LCD 'CR'	'CR LF'	Local keyboard disabled
LCE	LCE 'CR'	'CR LF'	Local keyboard enabled
RMD	RMD 'CR'	'CR LF'	Remote keyboard disabled
RME	RME 'CR'	'CR LF'	Remote keyboard enabled
SD?	SD? 'CR'	dd:ww:yy 'CR LF' ww = week yy = year	Software date of Master?
MK?	MK? 'CR'	aa 'CR LF'	Maschine "Mark" Version? aa=mark number: 01 = mark I, 02 = mark II
MT?	MT? 'CR'	aa 'CR LF'	Machine type? aa=machine type number 01=820,02=812,03=820MCH, 04=827MCH,05=807,06=816 07=810
SBA <address>	SBA <xxxx>	'CR LF'	Set SMPTE/EBU bus address (8280-FFFF) 8280 = lowest Bus address FFFF = highest Bus address
BA?	BA? 'CR'	xxxx 'CR LF'	Bus address?

**2.4 Installation of the Serial Interface 1.820.751 (SMPTE/EBU)**

Hardware definitions:

- Electrical standards according to RS 232C or RS422A (selectable with jumpers)
- Full-duplex
- Asynchronous transmission of the data, bit-serial and word-serial, according to the following diagram:

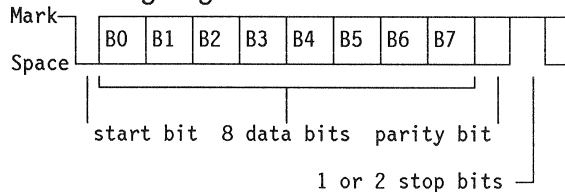

Odd or even parity and the number of stop bits (1 or 2) can be programmed.

- Baud rates for RS 232 and RS422 programmable as 9600 or 1200 baud, for operation in conjunction with an SMPTE bus it is preset to 38400 baud.
- Standard factory settings:  
 RS232  
 1 start bit  
 8 data bits  
 even parity  
 1 stop bit  
 9600 baud.

Pin assignment:

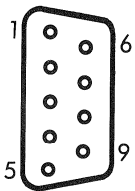

Pin	RS232	RS422
1	SHIELD	SHIELD
2	---	TRANSMIT A
3	RX	RECEIVE B
4	0,0 V	RECEIVE COMMON
5	---	---
6	0,0 V	TRANSMIT COMMON
7	TX	TRANSMIT B
8	---	RECEIVE A
9	SHIELD	SHIELD

Jumper:

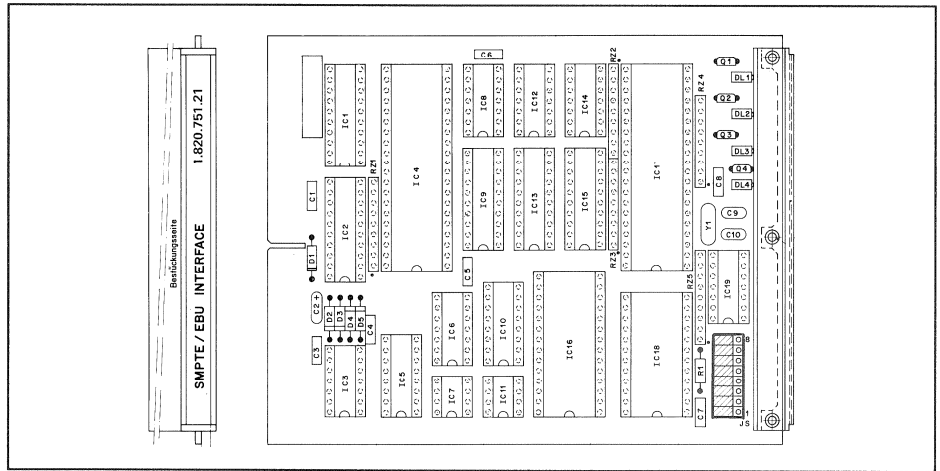

Fig. 2.8.5

Changeover of the operating mode and the electrical configuration:

	J8	J7	J6	J5	J4	J3	J2	J1
SMPT E BUS	BC	BC	BC	BC	BC		BC	BC
SERIAL RS232	AB	AB	AB	AB	AB		AB	AB
SERIAL RS422	AB	BC	BC	BC	AB		BC	BC

Changeover of the baud rates:

		J3
SMPT E BUS	38,4 kBd	BC
RS232/RS422	9600 Bd	BC
	1200 Bd	AB

Standard settings:

	J8	J7	J6	J5	J4	J3	J2	J1
SMPT E BUS	BC	BC	BC	BC	BC	BC	BC	BC
SERIAL RS232 9600 Baud	AB	AB	AB	AB	AB	BC	AB	AB

Pilot lamps

The four pilot LEDs on the front bracket of the module 1.820.751 are used for indicating different states, depending on whether the module is used as a serial interface (RS232/RS422) or as an SMPT E/EBU bus interface (programmabel with jumpers as described above).

**SMPTE/EBU bus:**

**INTERFACE SELECTED**  
 Glows when the interface receives an SEL ADDR and as long as it remains in the SELECT status.

**INTERFACE POLLED**  
 Glows when the interface receives a POLL ADDR and as long as it remain in the POLL status.

**INTERFACE IDLE/ACTIVE**  
 Glows as long as the interface waits for STX (control byte).

**FIFO TX/RX ACTIVE**  
 Glows when the interface receives data from the FIFO or transmits data to the FIFO.

**PCB RS232/RS422:**

**RX ACTIVE**  
 Glows as soon as the interface receives STX (control byte) and as long as it receives a message.

**TX ACTIVE**  
 Glows as long as the interface transmits a message.

**INTERFACE ACTIVE**  
 Glows as long as the interface waits for a BREAK signal or its own answer.

**FIFO TX/RX ACTIVE**  
 Glows when the interface receives data from the FIFO or transmits data to the FIFO.

**Software protocol:**

The host control system can transmit commands (function or parameter commands) or status requests to the A827 MCH. The A827 MCH acknowledges the commands and supplies status messages on request.

- Commands from the control system to the A827 MCH:

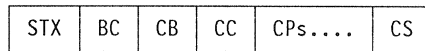

STX: is a control character and is transmitted as a start character (according to SMPTE recommendation: STX = 02H).  
 BC (byte count): contains the number of bytes that follow (excluding checksum).  
 CB (control byte):

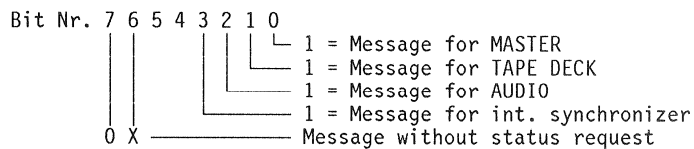

CC (command code): function or parameter command; refer to corresponding instruction set.  
 CP (parameter bytes): only for parameter commands; if more than one parameter byte exists, the MSB is transmitted first.  
 CS (checksum): Two's complement of the sum of all data transmitted before the checksum, excluding STX.

- Status request from the control system to the A827 MCH:

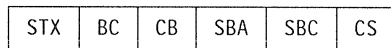

STX: is a control character and is transmitted as the start character (according to SMPTE recommendation: STX = 02H).  
 BC (byte count): 3 (fixed). CB (control byte):

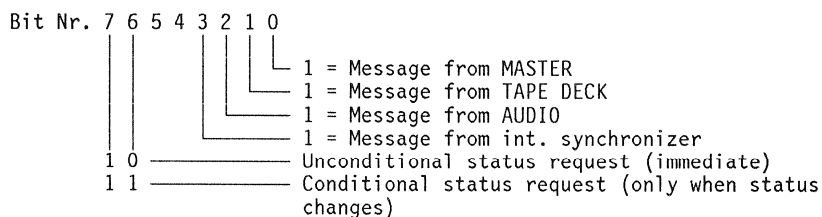



SBA, SBC (status request byte): SBA contains the base address, SBC the number of bytes of the requested status. CS (checksum): two's complement of the sum of all data transmitted before the checksum, excluding STX.

- Acknowledgment and status messages of the A827 MCH to the control system:

After the control system has transmitted a command block, it must wait for an acknowledgment from the A827 MCH before a new command block may be transmitted.

This acknowledgment can consist of a control character or a status message.

If no acknowledgment arrives within the time-out period (10 ms), the control system considers the transmission as faulty.

Possible acknowledgment:

Acknowledgment after correct transmission of commands or status change request with unchanged status:

ACK
-----

 ( = 04<sub>H</sub> according to SMPTE recommendation)

Acknowledgment after the following errors:

- Transmission error (framing, parity overrun) wrong command codes
- Time-out (2 sec) during the command transmission)

NAK
-----

 ( = 05<sub>H</sub> according to SMPTE recommendation)

Status message as an acknowledgment to:

- Unconditional status request
- Status change request with changed status

STX	BC	CB	SBA	SBC	STATUS	CS
-----	----	----	-----	-----	--------	----

STX: is a control character and is transmitted as the start character (according to SMPTE recommendation: STX = 02H).

BC (byte count): contains the number of bytes that follow (without checksum).

CB (control byte):

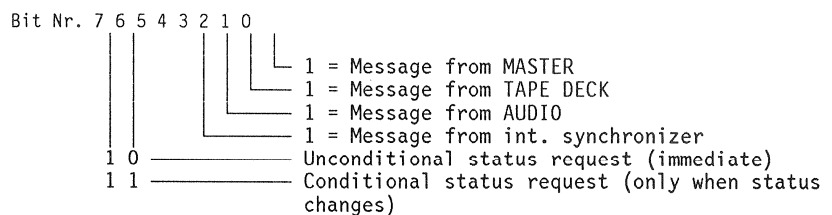

SBA, SBC (status request byte): SBA contains the base address, SBC the number of bytes of the request status.

CS (checksum): two's complement of the sum of all data transmitted before the checksum, excluding STX.

**Command list**

On request

## 2.5 How to Perform a Software Update

---

The A827 is equipped with 4 microprocessors and 9 EPROMs.

MPU Master	1.827.784.XX	3 EPROMs
MPU Audio	1.827.782.XX	3 EPROMs
MPU Tape Deck Control	1.820.781.XX	2 EPROMs
MPU Capstan Control	1.820.764.XX	1 EPROM

Also the following remote controls can be affected when the software is changed:

MPU Audio remote control	1.827.783.XX	EPROMs
■ Installed in	AUDIO REMOTE CONTROL 8 channels	21.328.521.00
or	AUDIO REMOTE CONTROL 24 channels	21.328.523.81

MPU Audio remote IF	1.820.787.XX	
■ Installed in the	PARALLEL CHANNEL CONTROL INTERFACE	21.328.540.00

All important parameters are stored in the master MPU and the audio MPU. The tape deck parameters (tape tensions, etc.) and the key assignment are stored in the master RAM.

The audio RAM serves as a buffer memory for all audio parameters for up to 48 channels (i.e. tape type A, tape type B, head block 24ch or 24 ch/(16ch and one 8ch channel configuration).

### Preparatory steps

Write down the following parameters:

- Master: - Tape tension parameters
- Enter the TAPE DECK ALIGNMENT data in the log:
  - SET LIBRARY WIND A: B:
  - SET MAX. WIND SPEED A: B:
  - SET ROLLBACK TIME :
  - SET MAX. REEL :
  - SET PLAY TENSION A: Left: 2"...,1" B: Left: 2"...,1"  
Right: 2"...,1" Right: 2"...,1"
  - SET WIND TENSION A: 2"...,1"... B: 2"...,1"...
  - SET EDIT TENSION A: 2"...,1"... B: 2"...,1"...
  - SET REV PLAY TENSION A: Left: B: Left:  
Right: Right:
  - SET ES-BUS ADDRESS :
  - SERIAL REMOTE FORMAT :
  - ASCII RS 232 BAUD RATE :
  - ASCII RS 232 MODE :
  - TRIM NOMINAL SPEED :

- Key assignment (if different from the standard programming)  
Any changes should be entered in the "Tree diagram, Section 1.7.10).
- Audio:** ■ The audio parameters can be written on tape  
(see maintenance instructions).
- Write down the audio parameters.

The following tables are very useful for this purpose:

**Please Note:** If different audio parameters haven't been set for tape types A and B, one table each must be maintained for both tape types. Likewise, if a 24 track unit has also been calibrated for a 16 channel and (or) an 8 channel headblock, the corresponding parameters for

- 16 channel head block tape type A
- 16 channel head block tape type B
- 8 channel head block tape type A
- 8 channel head block tape type B

must be written down.

At most four complete tables have to be maintained

- 1 × for 24 channels tape type A
- 1 × for 24 channels tape type B
- 1 × for 16+8 channels tape type A
- 1 × for 16+8 channels tape type B

- Audio remote control:  
Channel setup memory, if necessary, see Section 1.8.7.

# STUDER A827 MCH

**Model:** A827 ... channels  
**Serial number:** .....  
**Head number:** .....

**Tape recorder aligned for:**

**Input level:** .....  
**Output level:** .....  
**Load impedance:** .....  
**Tape type:** .....  
**Flux density:** .....  
**Equalization:** .....

## Repro

CHANNEL NUMBER	Audio Parameter								
	L E V E L			T R E B L E			B A S S		
	SPEED [IPS]			SPEED [IPS]			SPEED [IPS]		
	7.5	15	30	7.5	15	30	7.5	15	30
1	..	..	..	..	..	..	..	..	..
2	..	..	..	..	..	..	..	..	..
3	..	..	..	..	..	..	..	..	..
4	..	..	..	..	..	..	..	..	..
5	..	..	..	..	..	..	..	..	..
6	..	..	..	..	..	..	..	..	..
7	..	..	..	..	..	..	..	..	..
8	..	..	..	..	..	..	..	..	..
9	..	..	..	..	..	..	..	..	..
10	..	..	..	..	..	..	..	..	..
11	..	..	..	..	..	..	..	..	..
12	..	..	..	..	..	..	..	..	..
13	..	..	..	..	..	..	..	..	..
14	..	..	..	..	..	..	..	..	..
15	..	..	..	..	..	..	..	..	..
16	..	..	..	..	..	..	..	..	..
17	..	..	..	..	..	..	..	..	..
18	..	..	..	..	..	..	..	..	..
19	..	..	..	..	..	..	..	..	..
20	..	..	..	..	..	..	..	..	..
21	..	..	..	..	..	..	..	..	..
22	..	..	..	..	..	..	..	..	..
23	..	..	..	..	..	..	..	..	..
24	..	..	..	..	..	..	..	..	..

- Additional 8-channel headblock
- Additional 16-channel headblock

**Erase parameters  
CCIR/NAB**

REPROD.	[7.5 IPS]= .../....	[15 IPS] = .../....	[30 IPS] = .../....
RECORD.	[7.5 IPS]= .../....	[15 IPS] = .../....	[30 IPS] = .../....
SYNCHR.	[7.5 IPS]= .../....	[15 IPS] = .../....	[30 IPS] = .../....

Record

CHANNEL		AUDIO PARAMETER						
		L E V E L			T R E B L E			BIAS CAL
		SPEED [IPS]			SPEED [IPS]			SPEED [IPS]
NUMBER	7.5	15	30	7.5	15	30	15	
1	..	..	..	..	..	..	..	
2	..	..	..	..	..	..	..	
3	..	..	..	..	..	..	..	
4	..	..	..	..	..	..	..	
5	..	..	..	..	..	..	..	
6	..	..	..	..	..	..	..	
7	..	..	..	..	..	..	..	
8	..	..	..	..	..	..	..	
9	..	..	..	..	..	..	..	
10	..	..	..	..	..	..	..	
11	..	..	..	..	..	..	..	
12	..	..	..	..	..	..	..	
13	..	..	..	..	..	..	..	
14	..	..	..	..	..	..	..	
15	..	..	..	..	..	..	..	
16	..	..	..	..	..	..	..	
17	..	..	..	..	..	..	..	
18	..	..	..	..	..	..	..	
19	..	..	..	..	..	..	..	
20	..	..	..	..	..	..	..	
21	..	..	..	..	..	..	..	
22	..	..	..	..	..	..	..	
23	..	..	..	..	..	..	..	
24	..	..	..	..	..	..	..	

- Additional 8-channel headblock
- Additional 16-channel headblock

Master BIAS ALL channels: 7.5 ips.....  
 15 ips.....  
 30 ips.....

Erase parameters:

CH 1 = ....	CH 13 = ....
CH 2 = ....	CH 14 = ....
CH 3 = ....	CH 15 = ....
CH 4 = ....	CH 16 = ....
CH 5 = ....	CH 17 = ....
CH 6 = ....	CH 18 = ....
CH 7 = ....	CH 19 = ....
CH 8 = ....	CH 20 = ....
CH 9 = ....	CH 21 = ....
CH 10 = ....	CH 22 = ....
CH 11 = ....	CH 23 = ....
CH 12 = ....	CH 24 = ....

Synch

CHANNEL NUMBER		Audio Parameter								
		L E V E L			T R E B L E			B A S S		
		SPEED [IPS]			SPEED [IPS]			SPEED [IPS]		
		7.5	15	30	7.5	15	30	7.5	15	30
1		..	..	..	..	..	..	..	..	..
2		..	..	..	..	..	..	..	..	..
3		..	..	..	..	..	..	..	..	..
4		..	..	..	..	..	..	..	..	..
5		..	..	..	..	..	..	..	..	..
6		..	..	..	..	..	..	..	..	..
7		..	..	..	..	..	..	..	..	..
8		..	..	..	..	..	..	..	..	..
9		..	..	..	..	..	..	..	..	..
10		..	..	..	..	..	..	..	..	..
11		..	..	..	..	..	..	..	..	..
12		..	..	..	..	..	..	..	..	..
13		..	..	..	..	..	..	..	..	..
14		..	..	..	..	..	..	..	..	..
15		..	..	..	..	..	..	..	..	..
16		..	..	..	..	..	..	..	..	..
17		..	..	..	..	..	..	..	..	..
18		..	..	..	..	..	..	..	..	..
19		..	..	..	..	..	..	..	..	..
20		..	..	..	..	..	..	..	..	..
21		..	..	..	..	..	..	..	..	..
22		..	..	..	..	..	..	..	..	..
23		..	..	..	..	..	..	..	..	..
24		..	..	..	..	..	..	..	..	..

- Additional 8-channel headblock
- Additional 16-channel headblock

Test engineer: .....

Date: .....

**Updating the software**

1. Change the EPROMs
2. Remove the RAM and erase it by short-circuiting each RAM pin row with a screw driver or by pressing the RAM against a conductive surface, e.g. aluminum foil.

**Note:** ■ The microprocessor board index is increased by 1. For example: MPU Master 1.820.784.21 changes to 1.820.784.22.

**First time operation of the A827 MCH**

- Switch the tape recorder ON. After a short delay the error message "DATA LOST" appears on the service display, and the message "ERROR" appears on the tape timer. Press STORE on the service display.
- Switch the tape recorder OFF and ON again. The machine is now ready for operation. Acknowledge the error message by pressing the STORE key again.
- Read in the audio parameters (from tape) or reenter the corresponding values from the table.
- Reload the previously noted TAPE DECK ALIGNMENT parameters.

As soon as one of the parameters has been modified, the message "Warn: Default parameters loaded" disappears.

- Check the soft key programming on the A827 and check it on the serial remote control, if necessary:
  - F 001 to F 073
  - F 102 to F 104
  - F 201 to F 265
  - F 301 to F 357
- If the default programming of the keys is to be retained, one key must be programmed so that the message: "Warn: Default keys loaded" disappears.

**Example:** Reprogramming the rewind key [1]: Select F301 (rewind) in the menu tree and simultaneously press the STORE and "¼" keys. Also refer to Section 1.7.2.

2.6 Technical Data

2.6.1 General Data

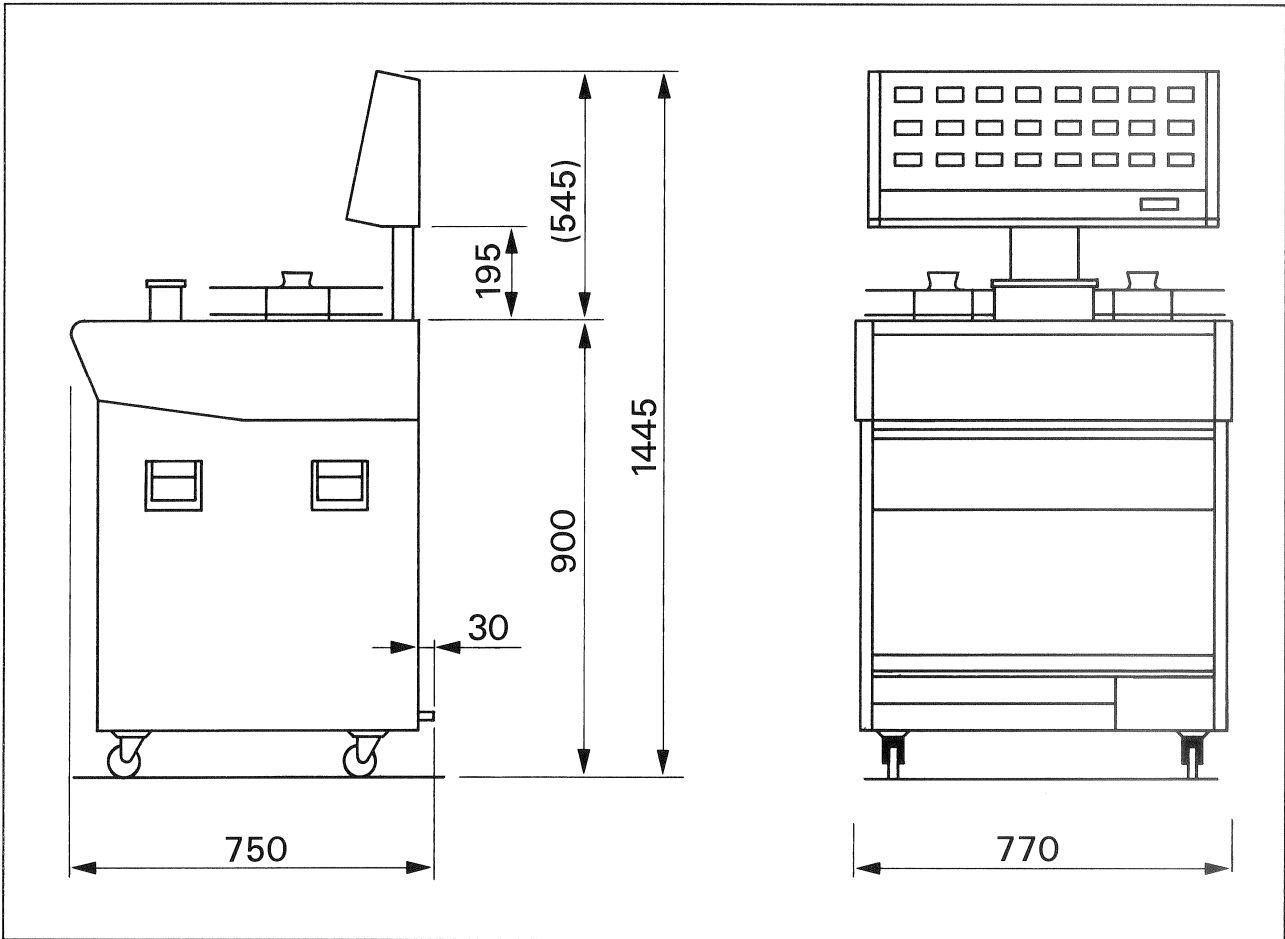

Fig. 1.6.1 [mm]

**Ambient temperatures:** 0°C to +40°C (+32°F to 104°F)  
(if good air circulation is provided)

**Relative humidity:** 20% ... 95%, non condensing

**Weight:** A827-24: 182 kg



## 2.6.2 Electrical Data

We reserve the right to make alterations as technical progress may warrant.

- Nominal tape speeds:** 30 – 15 – 7.5 ips  
76.2 – 38.1 – 19 cm/s  
Any of the nominal tape speeds can be selected via the speed select keys.  
Nominal speed adjustable  $\pm 0.2\%$  in increments of 0.025%.
- Variable tape speeds:**  $\pm 7$  semitones from nominal speed (+54% to -35%) displayed in % HT (half tones) or ips; programmable.
- Tape speed deviation:** Max.  $\pm 0.2\%$
- Tape slip:** Max. 0.1%
- Tape reel type:** Up to 14", NAB hub
- Tape width:** 25.4 mm (1")  
50.8 mm (2")
- Wow and flutter:** Peak weighted according to DIN 45507 or IEC Publ. 386, respectively. Ambient temperature 0° ... 40°C (32°F ... 104°F).
- |                     |                     |                       |
|---------------------|---------------------|-----------------------|
| 30 ips<br>76.2 cm/s | 15 ips<br>38.1 cm/s | 7.5 ips<br>19.05 cm/s |
| max. 0.03%          | max. 0.04%          | max. 0.06%            |
- Tape timer:** 6-digit LED, indicating hours, minutes, secondes and tenth of secondes for all tape speeds. Counts past zero with leading negative sign.  
Range: -9h 59min 59.9s to 23h 59min 59.9s
- Winding speed:** Programmable, 4 ... 590ips (0.1 ... 15 m/s), automatic speed reduction near end of tape.
- Rewind time:** Approx. 65 s for 762 m (2'500 ft) reel of tape (at 12 m/s wind speed setting).  
Approx. 55 s for 762 m (2'500 ft) reel of tape (at 15 m/s wind speed setting).
- Input:** Balanced and floating, with input transformer
- Impedance  $\geq 10 \text{ k}\Omega$ , 30 Hz ... 20 kHz.
- Input level:**
- Relative to reference flux, internally programmable, nominal +6 / +10 / +14 / +16dBu
  - Relative to operating level (according to NAB), internally programmable, nominal 0 / +4 / +8 / +10dBu  
(Internal adjustment range of the operating flux with above input levels: 100 to 1000nWb/m)

**Maximum input levels:** ■ With input transformer: +24 dBu

**Output:** Electronically balanced, without output transformer

■ Impedance  $\leq 30 \Omega$ , 30 Hz ... 20 kHz. Load  $\geq 200 \Omega$

**Output level:** ■ Relative to reference flux, internally programmable, nominal +6 / +10 / +14 / +16dBu  
 ■ Relative to operating level (according to NAB), internally programmable, nominal 0 / +4 / +8 / +10dBu  
 (Internal adjustment range of the reproduce gain for operating flux of 100 to 1000nWb/m)

**Maximum output level:** Without output transformer:  
 ■ Balanced (Load  $\geq 600 \Omega$ ): +24 dBu  
 ■ Unbalanced (Load  $\geq 600 \Omega$ ): +20 dBu  
 ■ Balanced (Load  $\geq 200 \Omega$ ): +22 dBu  
 ■ Unbalanced (Load  $\geq 200 \Omega$ ): +18 dBu

**Equalization:**

	30 ips 76.2 cm/s	15 ips 38.1 cm/s	7.5 ips 19.05 cm/s
NAB:	17.5/∞ μs (AES)	50/3180 μs	50/3180 μs
CCIR:	17.5/∞ μs (AES)	35/∞ μs	70/∞ μs

**Frequency response:** Record / reproduce

	30 ips 76.2 cm/s	15 ips 38.1 cm/s	7.5 ips 19.05 cm/s
±1 dB	60 Hz...20 kHz	60 Hz...18 kHz	60 Hz...12 kHz
±2 dB	50 Hz...20 kHz	30 Hz...20 kHz	30 Hz...15 kHz

**Sync frequency<sup>18</sup> response:** Jumper selectable "narrow or wide"  
 ■ narrow:

	30 ips 76.2 cm/s	15 ips 38.1 cm/s	7.5 ips 19.05 cm/s
±2 dB	50 Hz...12 kHz	30 Hz...12 kHz	30 Hz...8 kHz

■ wide:

	30 ips 76.2 cm/s	15 ips 38.1 cm/s	7.5 ips 19.05 cm/s
±2 dB	50 Hz...20 kHz	30 Hz...18 kHz	30 Hz...10 kHz

<sup>18</sup> Auxiliary sync output: Permanent sync output, unbalanced, aux equalized, e.g., for noise gate triggering.

**Signal to noise ratio<sup>19</sup>:** Referred to 6dB above operating level<sup>20</sup> unweighted noise in accordance with NAB standard.

8/16-Channel:	30 ips 76.2 cm/s	15 ips 38.1 cm/s	7.5 ips 19.05 cm/s
record-repr:	71 dB	67 dB	68 dB
record-sync:	69 dB	65 dB	66 dB

24-Channel:	30 ips 76.2 cm/s	15 ips 38.1 cm/s	7.5 ips 19.05 cm/s
record-repr:	69 dB	65 dB	67 dB
record-sync:	67 dB	65 dB	65 dB

**Signal to noise ratio<sup>21</sup>:** Referred to Peak recording level (514 nWb/m) unweighted noise in accordance with CCIR standard, CCIR equalization.

8/16-Channel:	30 ips 76.2 cm/s	15 ips 38.1 cm/s	7.5 ips 19.05 cm/s
record-repr:	64 dB	63 dB	60 dB
record-sync:	64 dB	61 dB	60 dB

24-Channel:	30 ips 76.2 cm/s	15 ips 38.1 cm/s	7.5 ips 19.05 cm/s
record-repr:	62 dB	60 dB	58 dB
record-sync:	60 dB	58 dB	57 dB

**Signal to noise ratio<sup>22</sup>:** Referred to 6 dB above operating level<sup>23</sup> weighted noise in accordance to ASA-A, RMS (IEC 179), NAB equalization.

8/16-Channel:	30 ips 76.2 cm/s	15 ips 38.1 cm/s	7.5 ips 19.05 cm/s
record-repr:	74 dB	71 dB	71 dB
record-sync:	72 dB	69 dB	69 dB

24-Channel:	30 ips 76.2 cm/s	15 ips 38.1 cm/s	7.5 ips 19.05 cm/s
record-repr:	72 dB	69 dB	70 dB
record-sync:	71 dB	68 dB	69 dB

<sup>19</sup> Measured with AMPEX 456 or äquivalent tape

<sup>20</sup> Operating level=514nWb/m 6dB above operating level=1028nWb/m=peak level

<sup>21</sup> Measured with AGFA PEM 469 or äquivalent tape

<sup>22</sup> Measured with AGFA PEM 496 or äquivalent tape

<sup>23</sup> Operating level=514nWb/m 6dB above operating level=1028nWb/m=peak level

**Signal to noise ratio<sup>24</sup>:**

Referred to 6dB above operating level weighted noise in accordance CCIR equalization.

8/16-Channel:		30 ips 76.2 cm/s	15 ips 38.1 cm/s	7.5 ips 19.05 cm/s
CCIR 468-2 quasi peak	record-repr:	56 dB	54 dB	51 dB
	record-sync:	56 dB	53 dB	51 dB
ASA-A (IEC 179) R.M.S	record-repr:	69 dB	67 dB	64 dB
	record-sync:	69 dB	67 dB	64 dB

24-Channel:		30 ips 76.2 cm/s	15 ips 38.1 cm/s	7.5 ips 19.05 cm/s
CCIR 468-2 quasi peak	record-repr:	54 dB	52 dB	49 dB
	record-sync:	54 dB	51 dB	49 dB
ASA-A (IEC 179) R.M.S	record-repr:	67 dB	65 dB	62 dB
	record-sync:	67 dB	65 dB	62 dB

**Distortion:**

At 1kHz (3rd harmonic) NAB equalization at operating level:

30 ips 76.2 cm/s	15 ips 38.1 cm/s	7.5 ips 19.05 cm/s
1% max.	1% max.	1% max.

**Crosstalk rejection<sup>25</sup>:**

Between adjacent tracks at 15ips (jumper narrow):

- 8/16 channel
  - Reproduce mode:  $\geq 40\text{dB}$  (80 Hz ... 12 kHz)
  - Sync mode:  $\geq 25\text{dB}$  at 1 kHz  
 $\geq 15\text{dB}$  at 10 kHz
- 24 channel:
  - Reproduce mode:  $\geq 40\text{dB}$  (100 Hz ... 12 kHz)
  - Sync mode:  $\geq 20\text{dB}$  at 1 kHz  
 $\geq 10\text{dB}$  at 10 kHz

**Erase efficiency:** 15ips, 514nWb/m  $\geq 75\text{dB}$  at 1kHz

**Erase frequency:** 153.6 kHz

**Bias frequency:** 153.6 kHz

**Power requirements:** 110V or 220V  $\pm 10\%$ , 50 ... 60 Hz

**Power consumption:** Approx. 1'100VA

**Safety standard:** Mains input according to IEC-Standard, Publication 65, Apparatus Class I

<sup>24</sup> Measured with AGFA PEM 496 or äquivalent tape

<sup>25</sup> Operating level (510 mWb/m tape flux)

2.6.3 Standard Calibration Data

These data are values that are transferred from the ROM into the RAM and the latches of the audio amplifiers in the event that the RAM of the Audio MPU data are lost. These values ensure that the recorder can still be used despite this loss of data, albeit with a possible minor degradation in audio quality. They are not intended as a substitute for individual calibration through which component and manufacturing tolerances can be compensated.

The data are represented as hexadecimal numbers, i.e. in the same form as they appear on the service display.

These data apply to Peak level (+6VU/0 dB PPM), 514 nWb/m and tape types 3M 226 (NAB) and Agfa PEM 469 (CCIR).

A827 MCH Default Values 11.06.91

		7,5 IPS				15 IPS				30 IPS			
		LVL	TRB	BASS	NAB/CCIR EQU	LVL	TRB	BASS	NAB/CCIR EQU	LVL	TRB	BASS	NAB/CCIR EQU
NORMAL 24CH	REPRO	75	30	9D	69/7C	70	35	92	69/52	75	16	92	2C/2C
	SYNC	85	50	A5	68/82	80	45	90	68/58	80	45	9E	2C/2C
	RECORD	4F	70	/	8F/76	50	40	/	67/8A	4D	2D	/	A8/A8
NORMAL 16/8CH	REPRO	45	48	9D	69/7C	45	28	88	61/4A	4B	1D	80	2C/2C
	SYNC	55	45	9D	68/82	50	2E	80	61/50	60	10	80	2C/2C
	RECORD	56	80	/	8F/76	56	48	/	67/8A	52	29	/	A8/A8
TC 24CH	REPRO	75	=	=	=	70	=	=	=	75	=	=	=
	SYNC	85	=	=	=	80	=	=	=	80	=	=	=
	RECORD	4F	=	=	o	50	=	=	o	4D	=	=	o
TC 16/8CH	REPRO	45	=	=	=	45	=	=	=	4B	=	=	=
	SYNC	55	=	=	=	55	=	=	=	60	=	=	=
	RECORD	56	=	=	o	56	=	=	o	52	=	=	o

= Values of normal (not TC) channels are loaded.

o Special values are written which cannot be externally adjusted.

MASTER BIAS	7,5 IPS	15 IPS	30 IPS
24 CH NORM	FB	00	05
16/8 CH NORM	FC	00	04
24 CH TC	=	=	=
16/8 CH TC	=	=	=

### 3 Standard Versions and Accessories

#### 3.1 Standard Versions Order Number

<b>A827-8-1"</b>	8-Channel machine for 1" tape	60.318.27071
<b>Note:</b>	The A827-8-1" cannot be upgraded to 16 or 24 channels.	
<b>A827-16(24)-2"</b>	16-Channel machine for 2" tape, field upgradable to 24 channels, with 24 VU-meters	60.318.27072
<b>A827-24-2"</b>	24-Channel machine for 2" tape	60.318.27073
<b>Important note:</b>	Machine requires channel remote control or parallel console audio remote interface for normal operation	
	<ul style="list-style-type: none"> <li>■ Additional operating manual (English)</li> <li>■ Additional service manual (English/German)</li> </ul>	10.27.1401 10.27.1390
<b>Headblocks</b>	8-Channel headblock (1")	1.050.150.82
	8-Channel headblock (1"), special version for adaptation to 2" tape decks	1.050.153.82
	16-Channel headblock (2")	1.050.151.82
	24-Channel headblock (2")	1.050.152.82
<b>Conversion Kits</b>	8-Channel 1" conversion kit for A827-16(24)-2" and A827-24-2"	1.820.494.00

#### 3.2 Accessories

<b>Reels:</b>	NAB metal reel, empty, 1" (10.5")	10.213.001.02
	NAB metal reel, empty, 1" (14")	10.353.001.01
	NAB metal reel, empty, 2" (10.5")	10.213.001.03
	NAB metal reel, empty, 2" (14")	10.353.001.02
	Reel flange DIN-type (14")	1.013.401.00
<b>Dust Cover</b>	Plastic, for all models	1.820.300.30
<b>Service Tools:</b>	Tool case (standard content) with soldering iron and demagnetizing choke for 110 V	20.020.001.10
	Tool case (standard content) with soldering iron and demagnetizing choke for 220 V	20.020.001.11
	Supplementary tool kit A827 MCH, incl. extension boards	20.020.001.43
	Extender board, 39-pin, for audio and logic modules	1.820.799.00
	Extender board, 64-pin, for logic modules	1.228.324.81
	Extender board for audio print	21.827.714.00
<b>STUDER Cleaning Kit in a Case:</b>	Contains 1 bottle of head cleaner, 1 bottle of aluminite cleaner, lint-free nonwoven fleece, buckskin	10.496.010.81
	Head cleaner, replacement bottle	10.496.021.00
	Head cleaner, 1 litre bottle	10.496.023.00
	Aluminite cleaner, replacement bottle	10.496.025.00
	Aluminite cleaner, 1 litre bottle	10.496.026.00
	Set of fleeces	10.496.010.01

3.3 Options

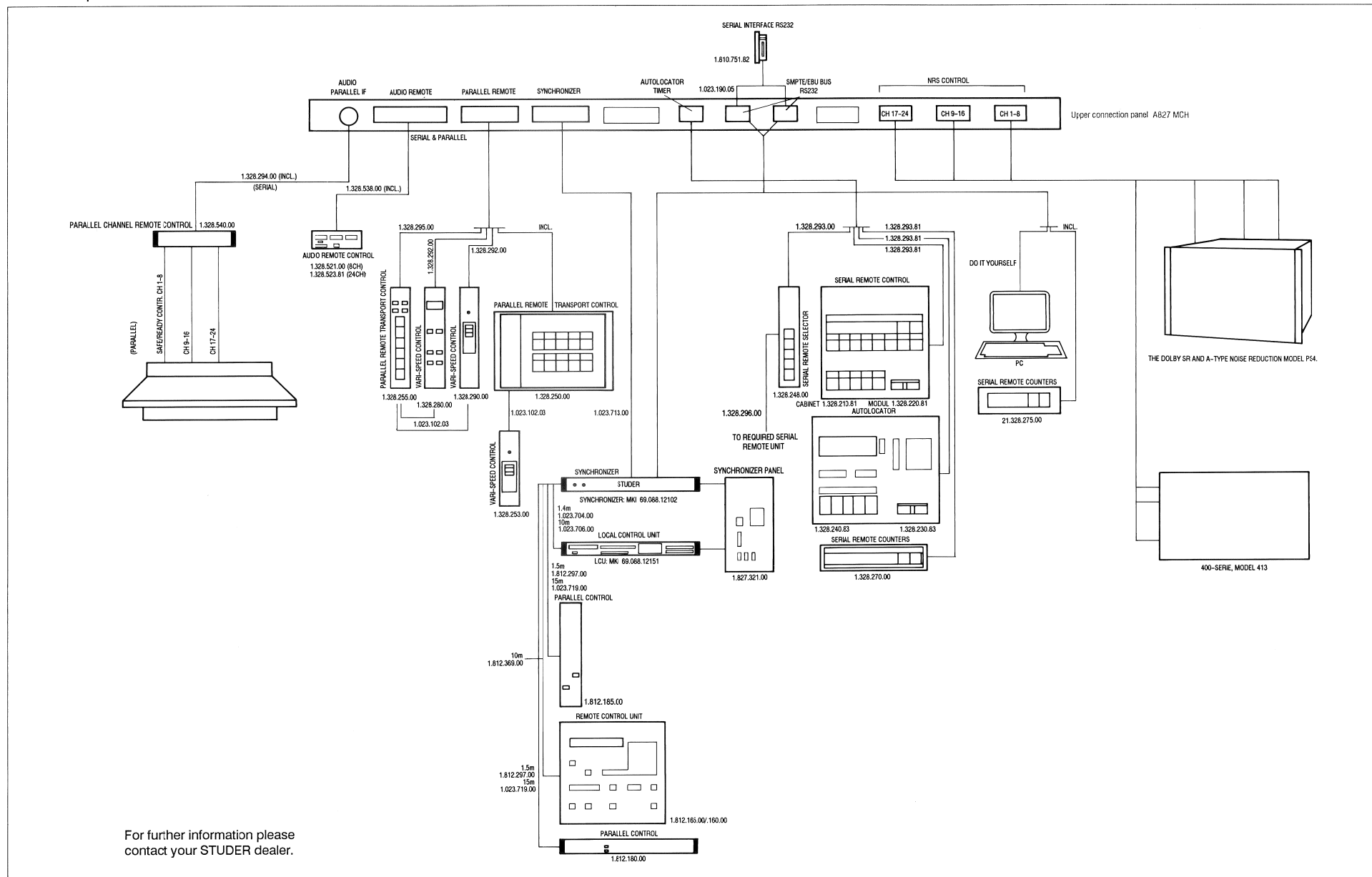

For further information please contact your STUDER dealer.

3.4 Remote control stands

Remote control stand  
1.328.190.00

For 2 control levels, accommodates up to 2 x 11 standard modules

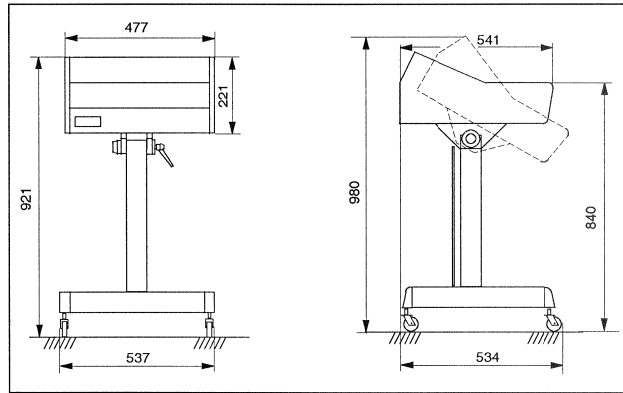

Dimensions in mm

Remote control stands  
1.328.171.00

For 3 control levels, accommodates up to 3 x 11 standard modules

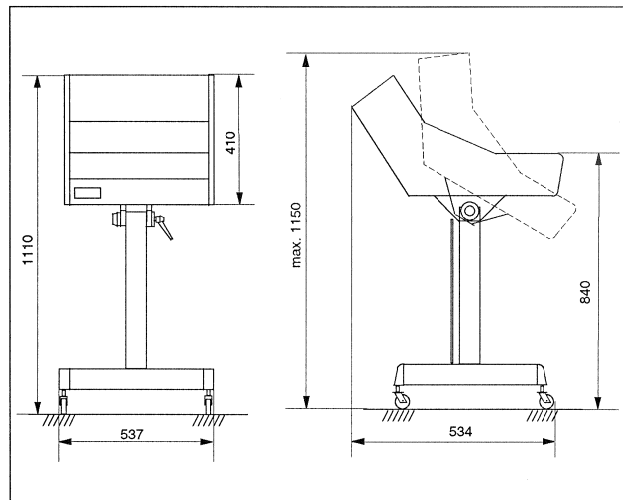

Dimensions in mm

Remote control stands  
1.328.170.00

For 3 control levels, accommodates up to 2x11 standard modules and 1 STUDER SYSTEM CONTROLLER SC 4008

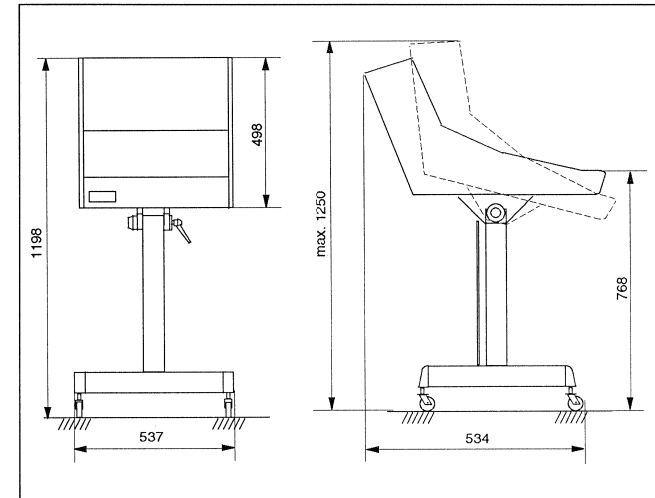

Dimensions in mm

All STUDER remote controls feature a modular design. The narrowest control unit consists of a STUDER standard module with fixed front plate dimensions. The width of larger front plates is always a multiple of the standard width, but the height remains the same. The front plate dimensions are accurately defined by the number of STUDER modules.

**Standard module size:** Height: 190 mm  
Width: 40.6 mm

**Dummy bezels:** Dummy bezels are used for covering blank positions in remote control stands that are not fully populated.

<b>Size:</b>	■ 1 Module	1.328.185.00
	■ 2 Modules	1.328.186.00
	■ 3 Modules	1.328.187.00
	■ 5 Modules	1.328.189.00
	■ 11 Modules	1.328.188.00

Front plate dimensions of the most frequently used remote control modules

<b>Serial remote control with tape timer and LAP indication:</b>	5 modules
<b>Autolocator:</b>	6 modules
<b>8 channel audio remote:</b>	11 modules
<b>16-24 channel audio remote:</b>	11 modules



---

## 4 Care Instructions

---

Daily care is limited to cleaning the heads, the capstan shaft, and the tape guidance elements.

Dust and oxide particles of the magnetic coating tend to accumulate on the heads and tape guides and can lead to dead gaps (so-called drop-outs).

Cleaning should be performed daily, or if contamination is visible, even more frequently.

Cleaning is best performed with a STUDER cleaning kit (Part No. 10.496.010.81) which contains all utensils required for cleaning the tape recorder, as well as a soundhead cleaning fluid and aluminite cleaner.

**Procedure:** Moisten the yellow piece of cloth with the soundhead cleaning fluid and clean all guidance elements that come in contact with the tape. Then wipe the cleaned parts with a dry section of the yellow piece of cloth.

The capstan shaft normally does not rotate when the recorder is not switched to play mode. A special function is available, however, to put the capstan motor in operation. For this purpose, unthread the tape and press the PLAY key.

**Important:** When you clean the capstan, make sure that no cleaning fluid penetrates into the bearing!

### Capstan motor

The capstan motor requires no maintenance.



## 4.1 Components Sensitive to Electrostatic Charges "ESE"

---

### Static electricity

In our daily activities numerous materials may be a possible source of static electricity. If certain circumstances are given, a person and the various things that are being handled may build up considerable static charges. When it comes to a discharge of such a static potential, very high peak power pulses may result. Even a small portion of such energy, when finding its way into an electronic component, will result in damage or even destruction of that component.

### Handling of ESE-assemblies

It must be our aim, therefore, to protect our products from damages and fault conditions that may be the result of electrostatic discharges. Correct handling of electronic assemblies when performing service work on equipment is of utmost importance. For this the following safe handling procedures have to be observed:

1. Discharge your body by touching earth before picking up an electronic assembly.
2. Touch your partner first (handshake) before handing an assembly to him.
3. When handling complete PC-boards, make it your standard practice to hold them only at their edge or at their front panel.
4. Never touch the conductive tracks, terminal points or components on a circuit board without having first discharged yourself.
5. Switch off the electric current supply to the equipment before removing or inserting an ESE assembly.
6. Always use ESE packaging for transportation or storage of ESE assemblies.
7. Make sure to use only tools that are approved for ESE work.
8. An earthed wrist-band is to be carried whenever performing any work on or with electronic assemblies, irrespective of whether they contain ESE or not.
9. Keep Styropor, PVC folis, plastic bags, etc. far away from ESE assemblies.